

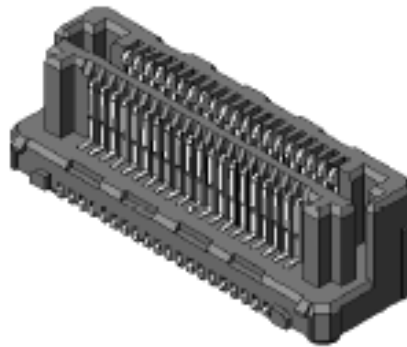

High Speed Characterization Report

LSHM-150-02.5-L-DV-A



Mates with

LSHM-150-02.5-L-DV-A

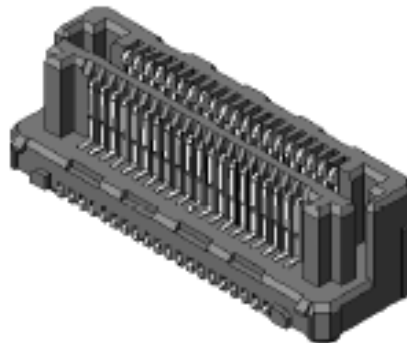

Description:

**High Speed Hermaphroditic Strip
Vertical Surface Mount, 0.5mm (.0197") Centerline,
5.0mm Board-to-Board Stack Height**

Series: LSHM, High Speed Hermaphroditic Strip, Vertical Surface Mount,
Description: 5.00 mm Stack Height, Two Row, 0.5mm (.0197") Contact Pitch, Board-to-Board

Table of Contents

| | |
|--|----|
| Connector Overview | 1 |
| Connector System Speed Rating | 1 |
| Frequency Domain Data Summary | 2 |
| Table 1 - Single-Ended Signaling System Performance | 2 |
| Table 2 - Differential Signaling System Performance | 2 |
| Bandwidth Chart – Single-Ended & Differential Insertion Loss | 3 |
| Time Domain Data Summary | 4 |
| Table 3 - Single-Ended Impedance (Ω) | 4 |
| Table 4 - Differential Impedance (Ω) | 4 |
| Table 5 - Single-Ended Crosstalk (%) | 5 |
| Table 6 - Differential Crosstalk (%) | 5 |
| Table 7 - Propagation Delay | 5 |
| Characterization Details | 6 |
| Differential and Single-Ended Data | 6 |
| Connector Signal to Ground Ratio | 6 |
| Frequency Domain Data | 8 |
| Time Domain Data | 8 |
| Appendix A – Frequency Domain Response Graphs | 10 |
| Single-Ended Application – Insertion Loss | 10 |
| Single-Ended Application – Return Loss | 10 |
| Single-Ended Application – NEXT Configurations | 11 |
| Single-Ended Application – FEXT Configurations | 11 |
| Differential Application – Insertion Loss | 12 |
| Differential Application – Return Loss | 12 |
| Differential Application – NEXT Configurations | 13 |
| Differential Application – FEXT Configurations | 13 |
| Appendix B – Time Domain Response Graphs | 14 |
| Single-Ended Application – Input Pulse, | 14 |
| Single-Ended Application – Impedance | 15 |
| Single-Ended Application – Propagation Delay | 15 |
| Single-Ended Application – NEXT, Worst Case Configuration | 16 |
| Single-Ended Application – FEXT, Worst Case Configuration | 16 |
| Single-Ended Application – NEXT, Best Case Configuration | 17 |
| Single-Ended Application – FEXT, Best Case Configuration | 17 |
| Single-Ended Application – NEXT, Across Row Configuration | 18 |
| Single-Ended Application – FEXT, Across Row Configuration | 18 |
| Differential Application – Input Pulse | 19 |

Series: LSHM, High Speed Hermaphroditic Strip, Vertical Surface Mount,

Description: 5.00 mm Stack Height, Two Row, 0.5mm (.0197") Contact Pitch, Board-to-Board

| | |
|---|----|
| Differential Application – Impedance | 20 |
| Differential Application – Propagation Delay | 20 |
| Differential Application – NEXT, Worst Case | 21 |
| Differential Application – FEXT, Worst Case | 21 |
| Differential Application – NEXT, Best Case | 22 |
| Differential Application – FEXT, Best Case | 22 |
| Differential Application – NEXT, Across Row Case | 23 |
| Differential Application – FEXT, Across Row Case | 23 |
| Appendix C – Product and Test System Descriptions | 24 |
| Product Description | 24 |
| Test System Description | 24 |
| PCB-102612-TST – 5.0mm Stack Height Test Fixtures | 25 |
| PCB-102612-TST PCB Array Panel | 25 |
| PCB-102612-TST, Set 11 & 12 Mapping | 26 |
| PCB-102612-TST, Set 21 & 22 Mapping | 27 |
| Micro-Probe TDA Calibration Board | 28 |
| CS-9 Calibration Substrate | 28 |
| Appendix D – Test and Measurement Setup | 28 |
| Appendix D – Test and Measurement Setup | 29 |
| CSA8000 Time Domain Test Setup | 29 |
| N5230C Frequency Domain (S-Parameter) Test Setup | 30 |
| Test Instruments | 30 |
| Probe Station Accessories | 30 |
| Test Cables & Adapters | 30 |
| Calibration Kits | 30 |
| Appendix E - Frequency and Time Domain Measurements | 31 |
| Sample Preparation | 31 |
| Frequency Domain Procedures | 31 |
| CSA8000 Setup | 31 |
| Insertion Loss (TDA conversion) | 32 |
| Return Loss (TDA conversion) | 32 |
| Near-End Crosstalk (TDA conversion) | 33 |
| Far-End Crosstalk (TDA conversion) | 33 |
| PNA Calibration & S-Parameter Measurements | 33 |
| Time Domain Procedures | 34 |
| Impedance(TDR) | 34 |
| Propagation Delay (TDT) | 34 |
| Near-End Crosstalk (TDT) | 34 |
| Far-End Crosstalk (TDT) | 34 |
| Appendix F – Glossary of Terms | 35 |

Series: LSHM, High Speed Hermaphroditic Strip, Vertical Surface Mount,

Description: 5.00 mm Stack Height, Two Row, 0.5mm (.0197") Contact Pitch, Board-to-Board

Connector Overview

The High Speed Hermaphroditic Strip LSHM 0.5MM (.0197") pitch connector is a slim row design providing high density in a vertical or right angle style PCB mounting orientation. LSHM ruggedized series includes shrouded high retention contacts that produce an audible click when mating. LSHM strip connectors are available in 20, 30, 40 or 50 contacts per row that includes an option for shielding. An offering of 10 mating heights are available between 5mm and 12mm stack heights for flexibility. Data presented in this report is applicable only to the 5.0 mm stack height.

Connector System Speed Rating

LSHM Connector Series, 0.5MM (.0197") Pitch, Vertical Mount, Slim Row to Two Row Design, Low Cost Blade & Beam, 5mm Stack Height

Signaling

Speed Rating

Single-Ended:

11.5GHz / 23Gbps

Differential:

7.0GHz / 14Gbps

The Speed Rating is based on the -3 dB insertion loss point of the connector system. The -3 dB point can be used to estimate usable system bandwidth in a typical, two-level signaling environment.

To calculate the Speed Rating, the measured -3 dB point is rounded-up to the nearest half-GHz level. The up rounding corrects for a portion of the test board's trace loss, since trace losses are included in the loss data in this report. The resulting loss value is then doubled to determine the approximate maximum data rate in Gigabits per second (Gbps).

For example, a connector with a -3 dB point of 7.8 GHz would have a Speed Rating of 8 GHz/ 16 Gbps. A connector with a -3 dB point of 7.2 GHz would have a Speed Rating of 7.5 GHz/15 Gbps.

Series: LSHM, High Speed Hermaphroditic Strip, Vertical Surface Mount,
Description: 5.00 mm Stack Height, Two Row, 0.5mm (.0197") Contact Pitch, Board-to-Board

Frequency Domain Data Summary

| Table 1 - Single-Ended Signaling System Performance | | | | |
|---|----------|---|---------|---------------------|
| Test Parameter | Filename | Source | Victim | |
| Insertion Loss | SL_1_1 | Tx, port1=LSHM_43, Rx, port3=LSHM_44 | | -3dB @ 11.1 GHz |
| Return Loss | SL_1_1 | Tx, port1=LSHM_43, Rx, port3=LSHM_44 | | ≤ -5dB to 11.1 GHz |
| Near-End Crosstalk | SN_1_1 | LSHM_41 | LSHM_39 | ≤ -23dB to 11.1 GHz |
| | SN_1_2 | LSHM_43 | LSHM_39 | ≤ -23dB to 11.1 GHz |
| | SN_1_3 | LSHM_7 | LSHM_8 | ≤ -27dB to 11.1 GHz |
| Far-End Crosstalk | SF_1_1 | LSHM_41 | LSHM_40 | ≤ -16dB to 11.1 GHz |
| | SF_1_2 | LSHM_43 | LSHM_40 | ≤ -13dB to 11.1 GHz |
| | SF_1_3 | LSHM_7 | LSHM_7 | ≤ -28dB to 11.1 GHz |

| Table 2 - Differential Signaling System Performance | | | | |
|---|----------|---|------------|--------------------|
| Test Parameter | Filename | Source | Victim | |
| Insertion Loss | DL_1_1 | Tx, port12=LSHM_89-91, Rx, port34=LSHM_90-92 | | -3dB @ 7.0GHz |
| Return Loss | DL_1_1 | Tx, port12=LSHM_89-91, Rx, port34=LSHM_90-92 | | ≤ -14dB to 7.0 GHz |
| Near-End Crosstalk | DN_1_1 | LSHM_91-93 | LSHM_87-89 | ≤ -16dB to 7.0 GHz |
| | DN_1_2 | LSHM_89-91 | LSHM_83-85 | ≤ -28dB to 7.0 GHz |
| | DN_1_3 | LSHM_3-5 | LSHM_4-6 | ≤ -30dB to 7.0 GHz |
| Far-End Crosstalk | DF_1_1 | LSHM_91-93 | LSHM_88-90 | ≤ -23dB to 7.0 GHz |
| | DF_1_2 | LSHM_89-91 | LSHM_84-86 | ≤ -32dB to 7.0 GHz |
| | DN_1_3 | LSHM_3-5 | LSHM_3-5 | ≤ -57dB to 7.0 GHz |

Pin Map (reference Appendix C for full description of test boards)

Series: LSHM, High Speed Hermaphroditic Strip, Vertical Surface Mount,
Description: 5.00 mm Stack Height, Two Row, 0.5mm (.0197") Contact Pitch, Board-to-Board

Bandwidth Chart – Single-Ended & Differential Insertion Loss

High Speed Hermaphroditic Strip LSHM 0.5MM (.0197") Pitch Connector

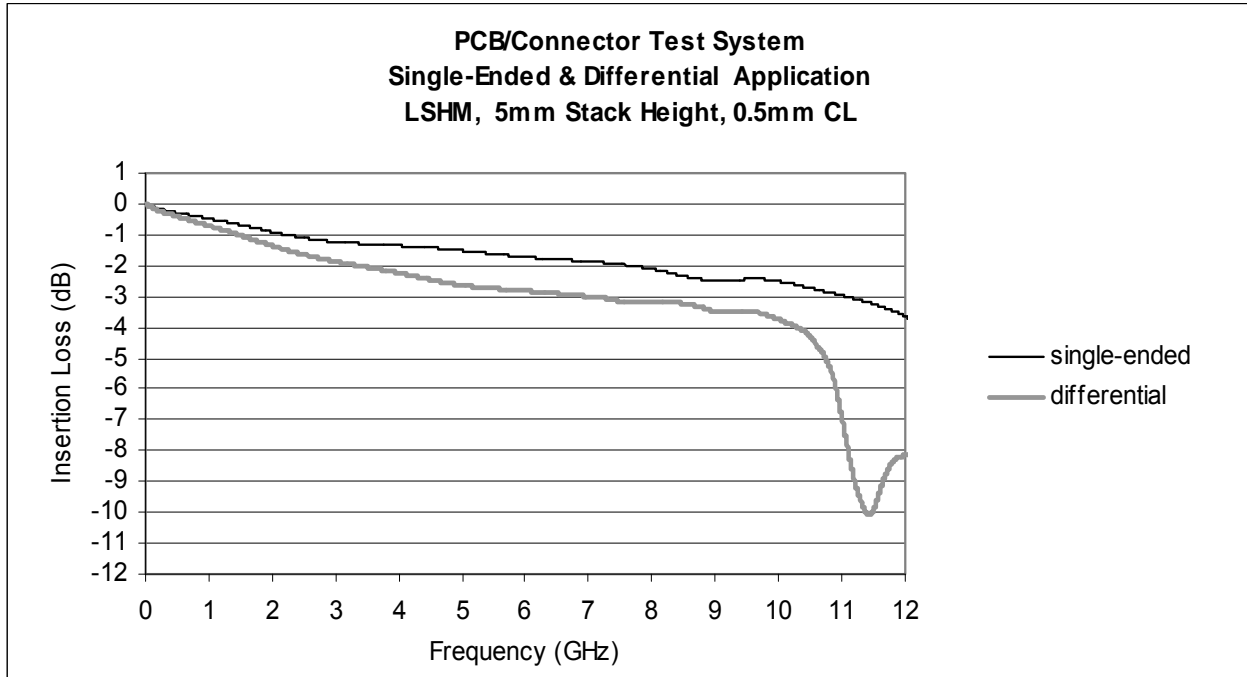

Series: LSHM, High Speed Hermaphroditic Strip, Vertical Surface Mount,
Description: 5.00 mm Stack Height, Two Row, 0.5mm (.0197") Contact Pitch, Board-to-Board

Time Domain Data Summary

| Table 3 - Single-Ended Impedance (Ω) | | | | | | | |
|---|--------|-------|--------|--------|--------|--------|------|
| Signal Risetime | 35±5ps | 50 ps | 100 ps | 250 ps | 500 ps | 750 ps | 1 ns |
| Maximum Impedance | 54.9 | 54.1 | 53.8 | 52.8 | 51.9 | 51.3 | 51.1 |
| Minimum Impedance | 41.9 | 43.5 | 44.8 | 48.2 | 49.2 | 49.2 | 49.3 |

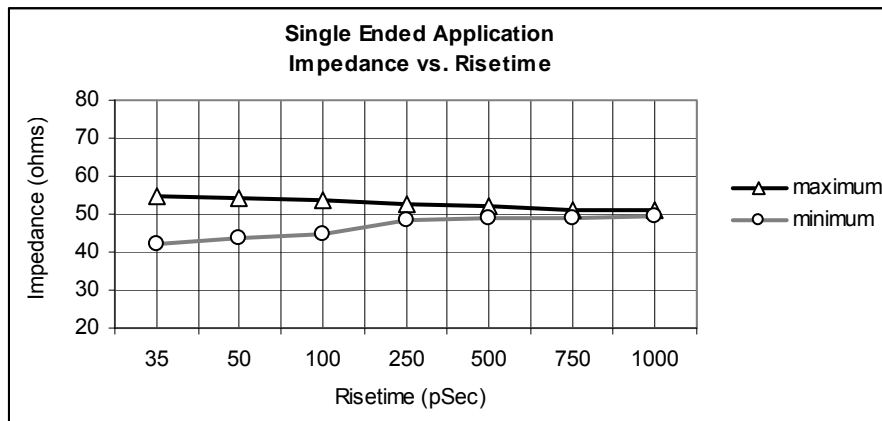

| Table 4 - Differential Impedance (Ω) | | | | | | | |
|---|--------|-------|--------|--------|--------|--------|-------|
| Signal Risetime | 35±5ps | 50 ps | 100 ps | 250 ps | 500 ps | 750 ps | 1 ns |
| Maximum Impedance | 107.4 | 107.1 | 106.8 | 104.7 | 103.4 | 102.7 | 102.3 |
| Minimum Impedance | 66.1 | 69.9 | 74.3 | 87.5 | 95.3 | 97.8 | 98.9 |

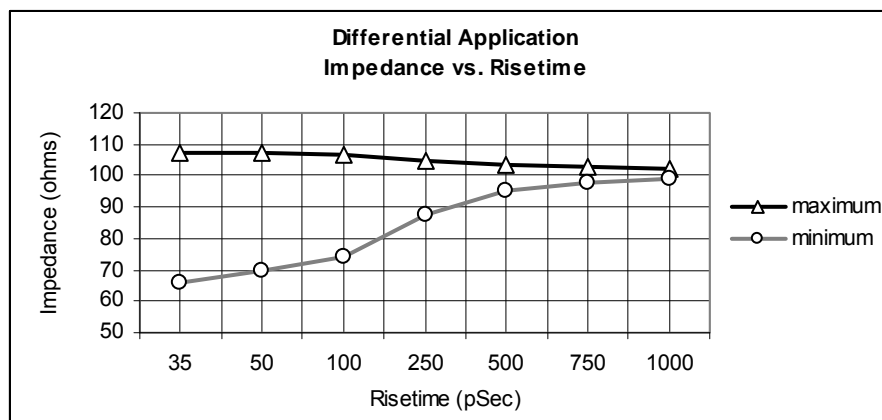

Series: LSHM, High Speed Hermaphroditic Strip, Vertical Surface Mount,

Description: 5.00 mm Stack Height, Two Row, 0.5mm (.0197") Contact Pitch, Board-to-Board

Table 5 - Single-Ended Crosstalk (%)

| Input (t _r) | | Source | Victim | 35±5ps | 50ps | 100ps | 250ps | 500ps | 750ps | 1ns |
|----------------------------|------------|---------|---------|--------|--------|--------|--------|--------|--------|--------|
| N E X T | μp1 to μp3 | LSHM_41 | LSHM_39 | 17.1 | 16.0 | 12.8 | 6.9 | 4.0 | 2.8 | 2.1 |
| | | LSHM_43 | LSHM_39 | 3.7 | 2.2 | 1.8 | 1.3 | < 1.0% | < 1.0% | < 1.0% |
| | | LSHM_7 | LSHM_8 | < 1.0% | < 1.0% | < 1.0% | < 1.0% | < 1.0% | < 1.0% | < 1.0% |
| F E X T | μp1 to μp5 | LSHM_41 | LSHM_40 | 3.2 | 2.4 | < 1.0% | < 1.0% | < 1.0% | < 1.0% | < 1.0% |
| | | LSHM_43 | LSHM_40 | 6.0 | 3.8 | 2.1 | < 1.0% | < 1.0% | < 1.0% | < 1.0% |
| | | LSHM_7 | LSHM_7 | < 1.0% | < 1.0% | < 1.0% | < 1.0% | < 1.0% | < 1.0% | < 1.0% |

Table 6 - Differential Crosstalk (%)

| Input (t _r) | | Source | Victim | 35±5ps | 50ps | 100ps | 250ps | 500ps | 750ps | 1ns |
|----------------------------|---|------------|------------|--------|--------|--------|--------|--------|--------|--------|
| N E X T | μp1 ⁺ 2 ⁻ to μp3 ⁺ 4 ⁻ | LSHM_91-93 | LSHM_87-89 | 4.8 | 4.5 | 3.7 | 2.2 | 1.4 | < 1.0% | < 1.0% |
| | | LSHM_89-91 | LSHM_83-85 | < 1.0% | < 1.0% | < 1.0% | < 1.0% | < 1.0% | < 1.0% | < 1.0% |
| | | LSHM_3-5 | LSHM_4-6 | < 1.0% | < 1.0% | < 1.0% | < 1.0% | < 1.0% | < 1.0% | < 1.0% |
| F E X T | μp1 ⁺ 2 ⁻ to μp5 ⁺ 6 ⁻ | LSHM_91-93 | LSHM_88-90 | 2.0 | 1.7 | 1.4 | < 1.0% | < 1.0% | < 1.0% | < 1.0% |
| | | LSHM_89-91 | LSHM_84-86 | < 1.0% | < 1.0% | < 1.0% | < 1.0% | < 1.0% | < 1.0% | < 1.0% |
| | | LSHM_3-5 | LSHM_3-5 | < 1.0% | < 1.0% | < 1.0% | < 1.0% | < 1.0% | < 1.0% | < 1.0% |

Table 7 - Propagation Delay

| Configuration | | Signal Path | Mated Connector Only |
|---------------|--------------|--|----------------------|
| Single-Ended | μp1 to μp8 | Tx, port1=LSHM_43, Rx, port3=LSHM_44 | 44ps |
| Differential | μp12 to μp78 | Tx, port12=LSHM_89-91, Rx, port34=LSHM_90-92 | 31ps |

Pin Map (reference Appendix C for full description of test boards)

Series: LSHM, High Speed Hermaphroditic Strip, Vertical Surface Mount,

Description: 5.00 mm Stack Height, Two Row, 0.5mm (.0197") Contact Pitch, Board-to-Board

Characterization Details

This report presents data that characterizes the signal integrity response of a connector pair in a controlled printed circuit board (PCB) environment. All efforts are made to reveal typical best-case responses inherent to the system under test (SUT).

In this report, the SUT includes the test PCB from drive-side probe tip to receive side probe tip. PCB effects are not removed or de-embedded from test data. PCB designs with impedance mismatch, large losses, skew, cross talk, or similar impairments can have a significant impact on observed test data. Therefore, great design effort is put forth to limit these effects in the PCB utilized in these tests. Some board related effects, such as pad-to-ground capacitance and trace loss, are included in the data presented in this report. However, other effects, such as via coupling or stub resonance, are not evaluated here. Such effects are addressed and characterized fully by the Samtec [Final Inch®](#) products.

Additionally, intermediate test signal connections can mask the connectors' true performance. Such connection effects are minimized by using high performance test cables, adapters, and microwave probes. Where appropriate, calibration and de-embedding routines are also used to reduce residual effects.

Differential and Single-Ended Data

Most Samtec connectors can be used successfully in both differential and single-ended applications. However, electrical performance will differ depending on the signal drive type. In this report, data is presented for both differential and single-ended drive scenarios.

Connector Signal to Ground Ratio

Samtec connectors are most often designed for generic applications, and can be implemented using various signal and ground pin assignments. In high-speed systems, provisions must be made in the interconnect for signal return currents. Such paths are often referred to as "ground". In some connectors, a ground plane or blade, or an outer shield is used as the signal return, while in others; connector pins are used as signal returns. Various combinations of signal pins, ground blades, and shields can also be utilized. Electrical performance can vary significantly depending upon the number and location of ground pins.

In general, the more pins dedicated to ground, the better electrical performance will be. But dedicating pins to ground reduces signal density of a connector. So, care must be taken when choosing signal/ground ratios in cost or density-sensitive applications.

For this connector, the following array configurations are evaluated:

Series: LSHM, High Speed Hermaphroditic Strip, Vertical Surface Mount,
Description: 5.00 mm Stack Height, Two Row, 0.5mm (.0197") Contact Pitch, Board-to-Board

open pin field grounded pin field

signal aggressor or signal victim pins

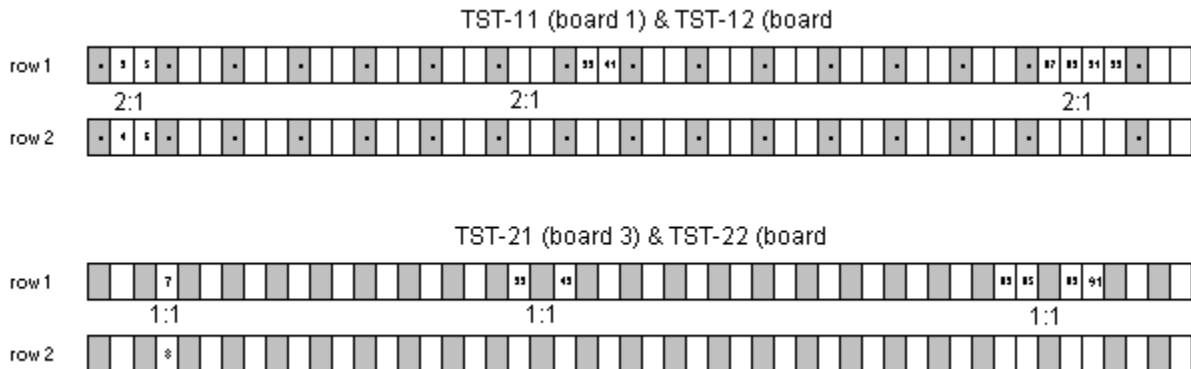

Single-Ended Impedance:

- Well-referenced line; 1:1, S:G ratio

Single-Ended Crosstalk:

- Well-referenced line; mimics 1:1 S:G ratio
- 2:1 S:G ratio

Only one single-ended signal was driven for crosstalk measurements.

Differential Impedance:

- Well-referenced line 1:1, S:G ratio

Differential Crosstalk:

- Well-referenced line; mimics 1:1 S:G ratio
- Higher Signal Density, 2:1 S:G ratio
- Full-Row Differential

Only one differential pair was driven for crosstalk measurements.

*In all cases where a center ground blade is present in the connector it is always grounded to the PCB. Only one single-ended signal or differential pair was driven for crosstalk measurements.

Series: LSHM, High Speed Hermaphroditic Strip, Vertical Surface Mount,

Description: 5.00 mm Stack Height, Two Row, 0.5mm (.0197") Contact Pitch, Board-to-Board

Other configurations can be evaluated upon request. Please contact sig@samtec.com for more information.

In a real system environment, active signals might be located at the outer edges of the signal contacts of concern, as opposed to the ground signals utilized in laboratory testing. For example, in a single-ended system, a pin-out of "SSSS", or four adjacent single ended signals, might be encountered, as opposed to the "GSG" and "GSSG" configurations tested in the laboratory. Electrical characteristics in such applications could vary slightly from laboratory results. But in most applications, performance can safely be considered equivalent.

Signal Edge Speed (Rise Time):

In pulse signaling applications, the perceived performance of the interconnect, can vary significantly depending on the edge rate or rise time of the exciting signal. For this report, the fastest rise time used was 35 +/-5 ps. Generally, this should demonstrate worst-case performance.

In many systems, the signal edge rate will be significantly slower at the connector than at the driver launch point. To estimate interconnect performance at other edge rates, data is provided for several rise times between 30 ps and 1.0 ns.

For this report, measured rise times were at 10%-90% signal levels.

Frequency Domain Data

Frequency domain parameters are helpful in evaluating the connector system's signal loss and crosstalk characteristics across a range of sinusoidal frequencies. In this report, parameters presented in the frequency domain are insertion loss, return loss, and near-end and far-end crosstalk. Other parameters or formats, such as VSWR or S-parameters, may be available upon request. Please contact our Signal Integrity Group at sig@samtec.com for more information.

Frequency performance characteristics for the SUT are generated from time domain measurements using Fourier Transform calculations. Procedures and methods used in generating the SUT's frequency domain data are provided in the frequency domain test procedures in [Appendix E](#) of this report.

Time Domain Data

Time Domain parameters indicate impedance mismatch versus length, signal propagation time, and crosstalk in a pulsed signal environment. Time Domain data is provided in [Appendix E](#) of this report. Parameters or formats not included in this report may be available upon request. Please contact our Signal Integrity Group at sig@samtec.com for more information.

Series: LSHM, High Speed Hermaphroditic Strip, Vertical Surface Mount,

Description: 5.00 mm Stack Height, Two Row, 0.5mm (.0197") Contact Pitch, Board-to-Board

Reference plane impedance is 50 ohms for single-ended measurements and 100 ohms for differential measurements. The fastest risetime signal exciting the SUT is 35 ± 5 picoseconds.

In this report, propagation delay is defined as the signal propagation time through the PCB connector pads and connector pair. It does not include PCB traces. Delay is measured at 35 ± 5 picoseconds signal risetime. Delay is calculated as the difference in time measured between the 50% amplitude levels of the input and output pulses.

Crosstalk or coupled noise data is provided for various signal configurations. All measurements are single disturber. Crosstalk is calculated as a ratio of the input line voltage to the coupled line voltage. The input line is sometimes described as the active or drive line. The coupled line is sometimes described as the quiet or victim line. Crosstalk ratio is tabulated in this report as a percentage. Measurements are made at both the near-end and far-end of the SUT.

Data for other configurations may be available. Please contact our Signal Integrity Group at sig@samtec.com for further information.

As a rule of thumb, 10% crosstalk levels are often used as a general first pass limit for determining acceptable interconnect performance. But modern system crosstalk tolerance can vary greatly. For advice on connector suitability for specific applications, please contact our Signal Integrity Group at sig@samtec.com.

Additional information concerning test conditions and procedures is located in the appendices of this report. Further information may be obtained by contacting our Signal Integrity Group at sig@samtec.com.

Series: LSHM, High Speed Hermaphroditic Strip, Vertical Surface Mount,
Description: 5.00 mm Stack Height, Two Row, 0.5mm (.0197") Contact Pitch, Board-to-Board

Appendix A – Frequency Domain Response Graphs

Single-Ended Application – Insertion Loss

Configuration: Tx, port1=LSHM_43, Rx, port3=LSHM_44

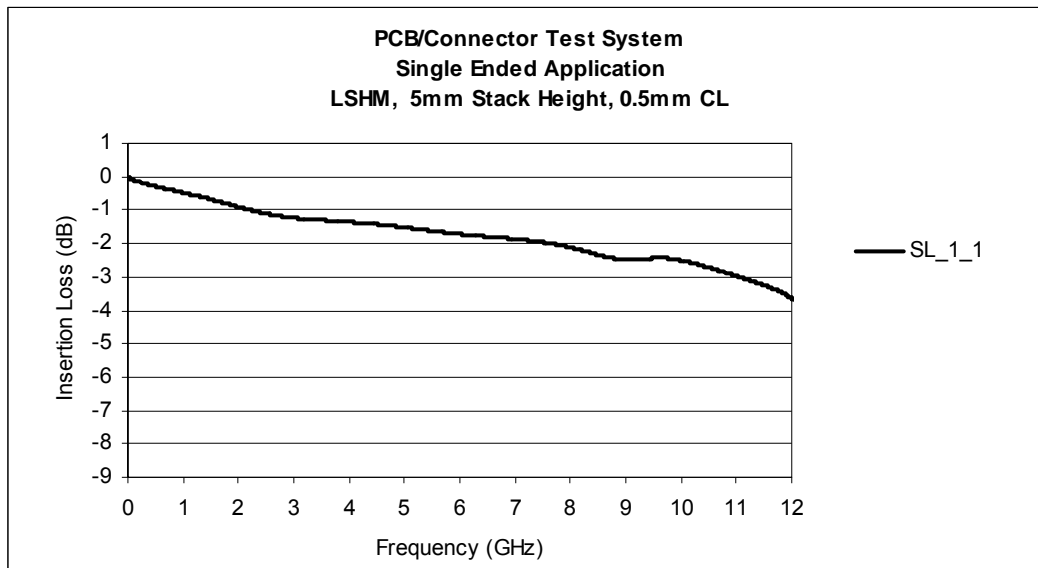

Single-Ended Application – Return Loss

Configuration: Tx, port1=LSHM_43, Rx, port3=LSHM_44

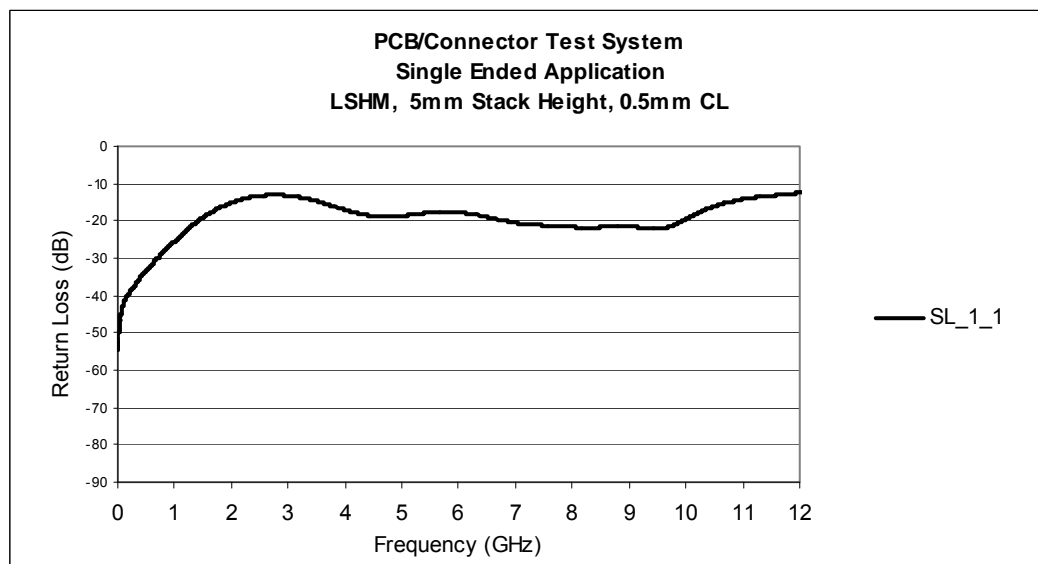

Series: LSHM, High Speed Hermaphroditic Strip, Vertical Surface Mount,
Description: 5.00 mm Stack Height, Two Row, 0.5mm (.0197") Contact Pitch, Board-to-Board

Single-Ended Application – NEXT Configurations

| | |
|---------|---------|
| LSHM_41 | LSHM_39 |
| LSHM_43 | LSHM_39 |
| LSHM_7 | LSHM_8 |

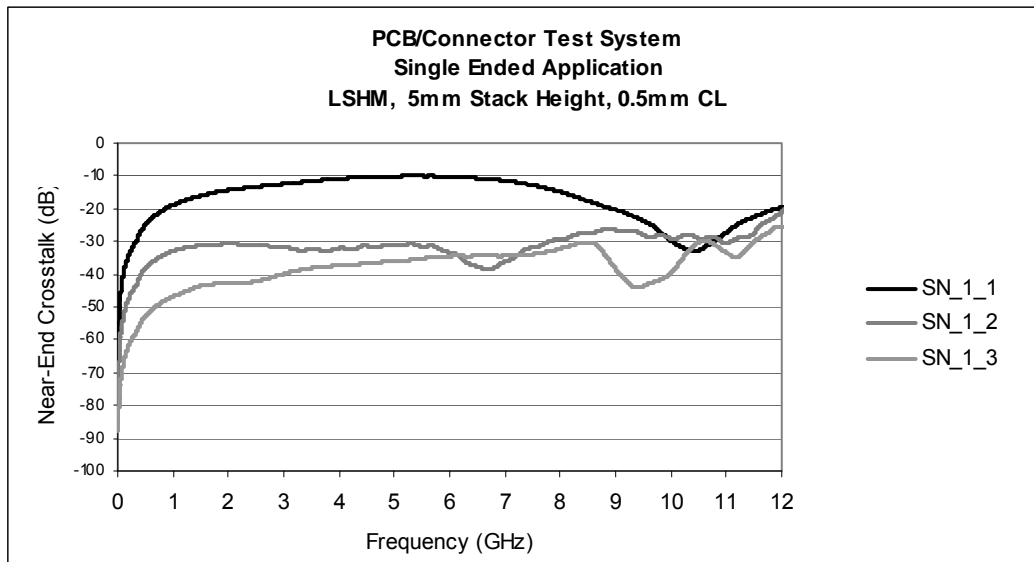

Single-Ended Application – FEXT Configurations

| | |
|---------|---------|
| LSHM_41 | LSHM_40 |
| LSHM_43 | LSHM_40 |
| LSHM_7 | LSHM_7 |

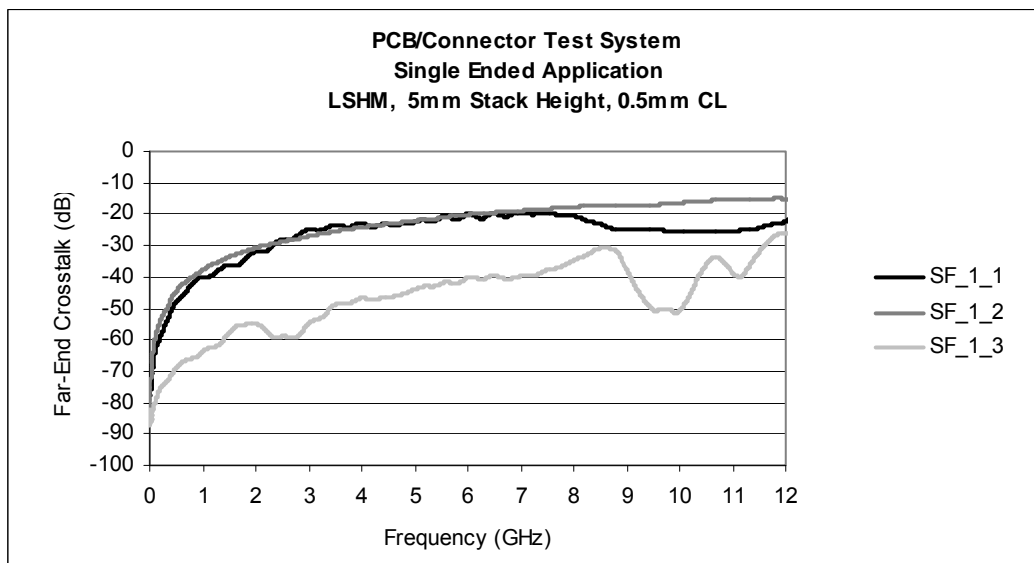

Series: LSHM, High Speed Hermaphroditic Strip, Vertical Surface Mount,
Description: 5.00 mm Stack Height, Two Row, 0.5mm (.0197") Contact Pitch, Board-to-Board

Differential Application – Insertion Loss

Configuration: Tx, port12=LSHM_89-91, Rx, port34=LSHM_90-92

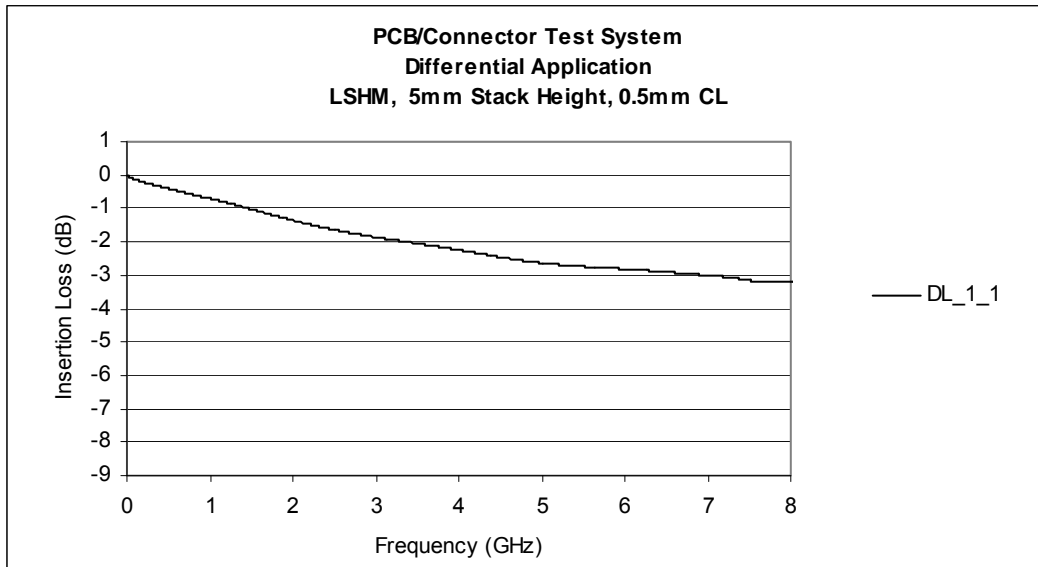

Differential Application – Return Loss

Configuration: Tx, port12=LSHM_89-91, Rx, port34=LSHM_90-92

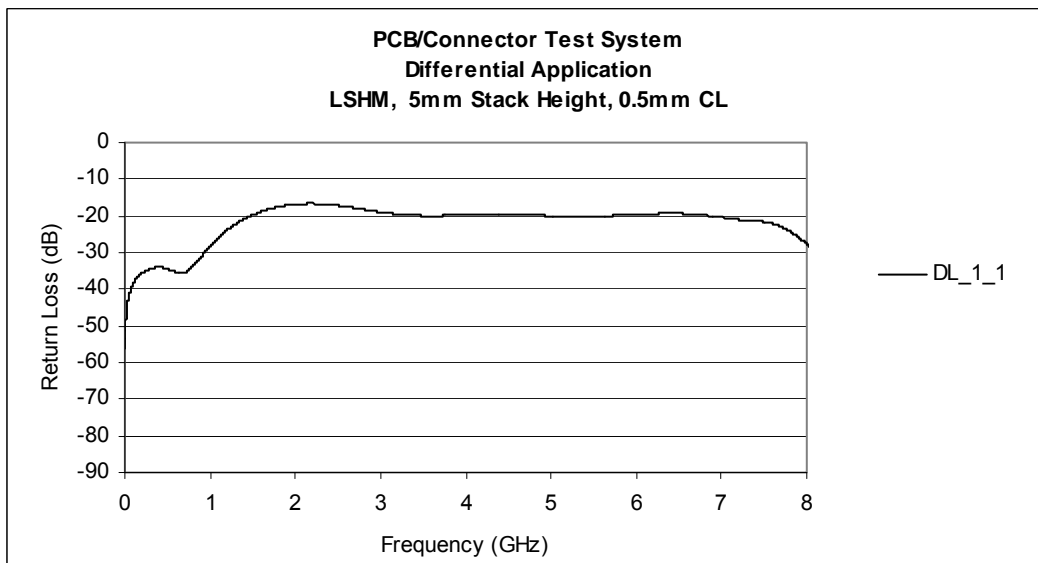

Series: LSHM, High Speed Hermaphroditic Strip, Vertical Surface Mount,
Description: 5.00 mm Stack Height, Two Row, 0.5mm (.0197") Contact Pitch, Board-to-Board

Differential Application – NEXT Configurations

| | |
|------------|------------|
| LSHM_91-93 | LSHM_87-89 |
| LSHM_89-91 | LSHM_83-85 |
| LSHM_3-5 | LSHM_4-6 |

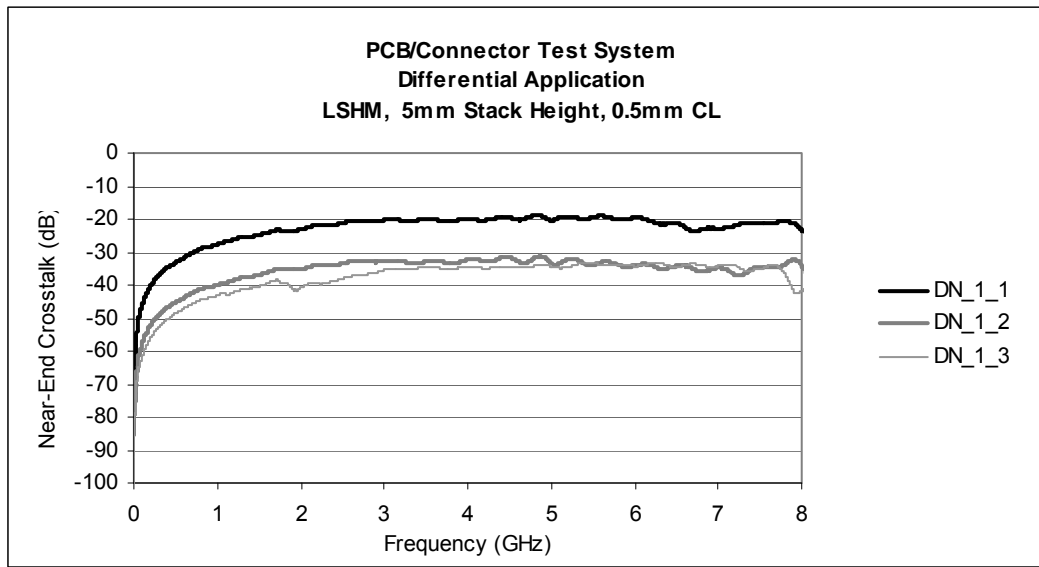

Differential Application – FEXT Configurations

| | |
|------------|------------|
| LSHM_91-93 | LSHM_88-90 |
| LSHM_89-91 | LSHM_84-86 |
| LSHM_3-5 | LSHM_3-5 |

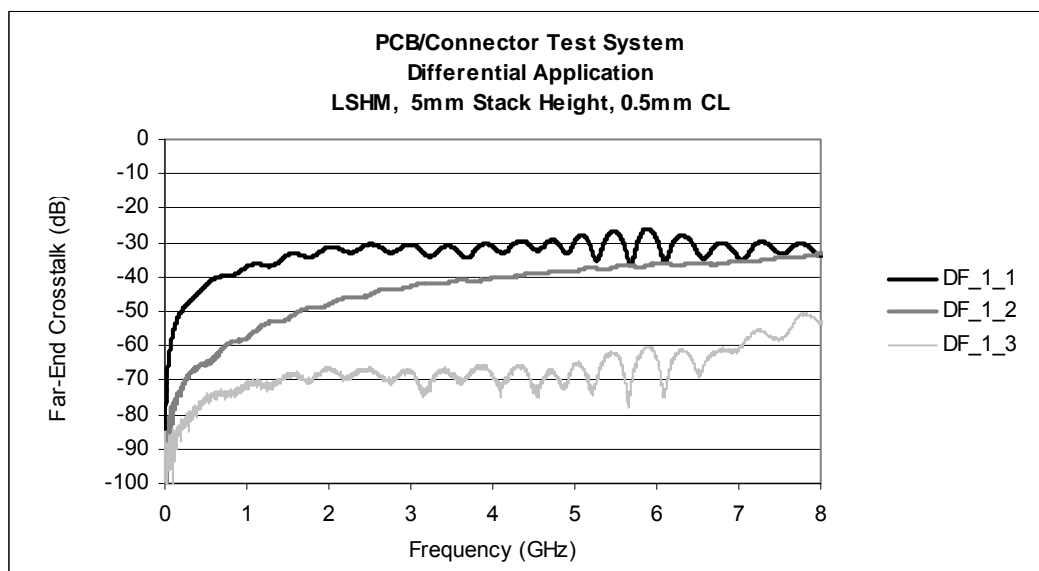

Series: LSHM, High Speed Hermaphroditic Strip, Vertical Surface Mount,
Description: 5.00 mm Stack Height, Two Row, 0.5mm (.0197") Contact Pitch, Board-to-Board

Appendix B – Time Domain Response Graphs

Single-Ended Application – Input Pulse,
port1= μ probe Tx1 port3= μ probe Rx1

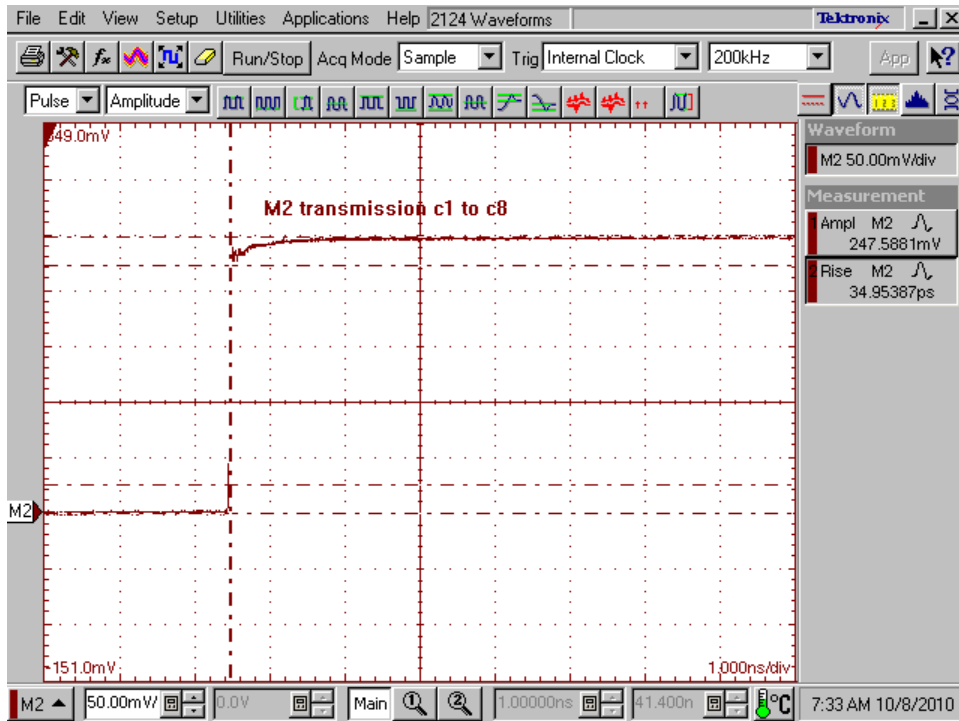

Series: LSHM, High Speed Hermaphroditic Strip, Vertical Surface Mount,
Description: 5.00 mm Stack Height, Two Row, 0.5mm (.0197") Contact Pitch, Board-to-Board

Single-Ended Application – Impedance

Configuration: Tx, port1=LSHM_43, Rx, port3=LSHM_44

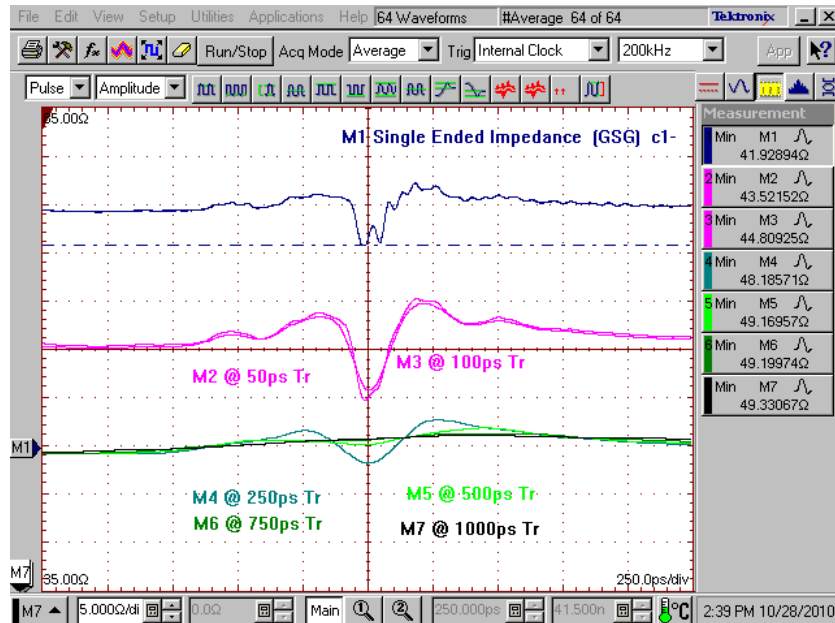

Single-Ended Application – Propagation Delay

Configuration: Tx, port1=LSHM_43, Rx, port3=LSHM_44

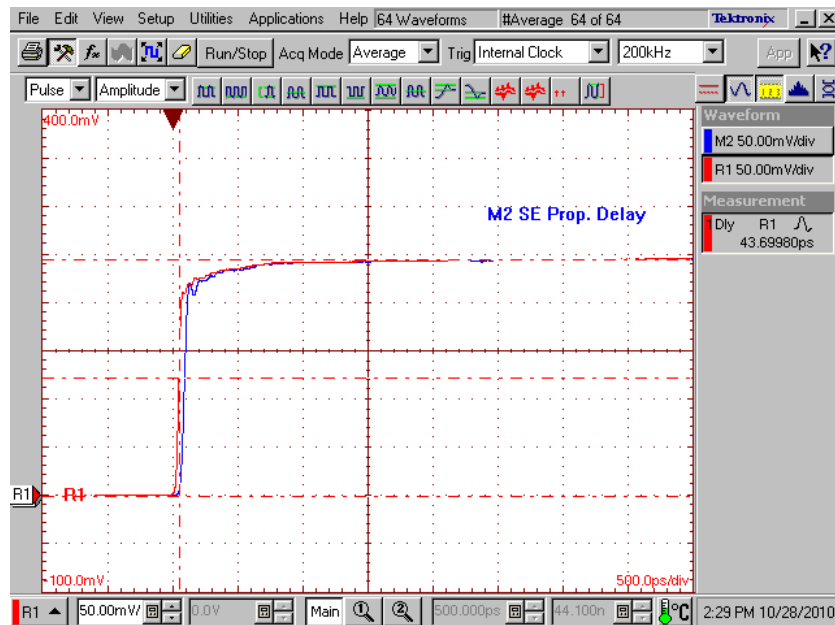

Series: LSHM, High Speed Hermaphroditic Strip, Vertical Surface Mount,
Description: 5.00 mm Stack Height, Two Row, 0.5mm (.0197") Contact Pitch, Board-to-Board

Single-Ended Application – NEXT, Worst Case Configuration

LSHM_41 LSHM_39

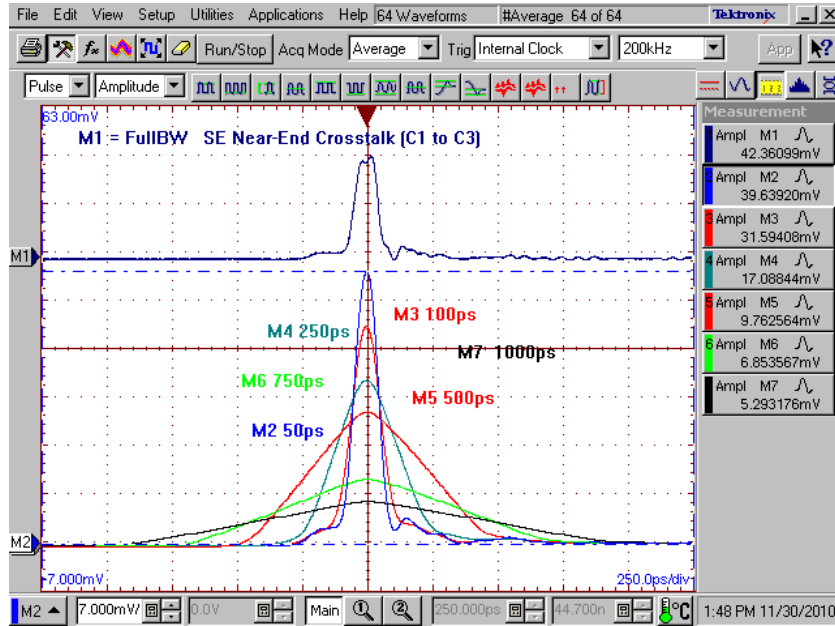

Single-Ended Application – FEXT, Worst Case Configuration

LSHM_41 LSHM_40

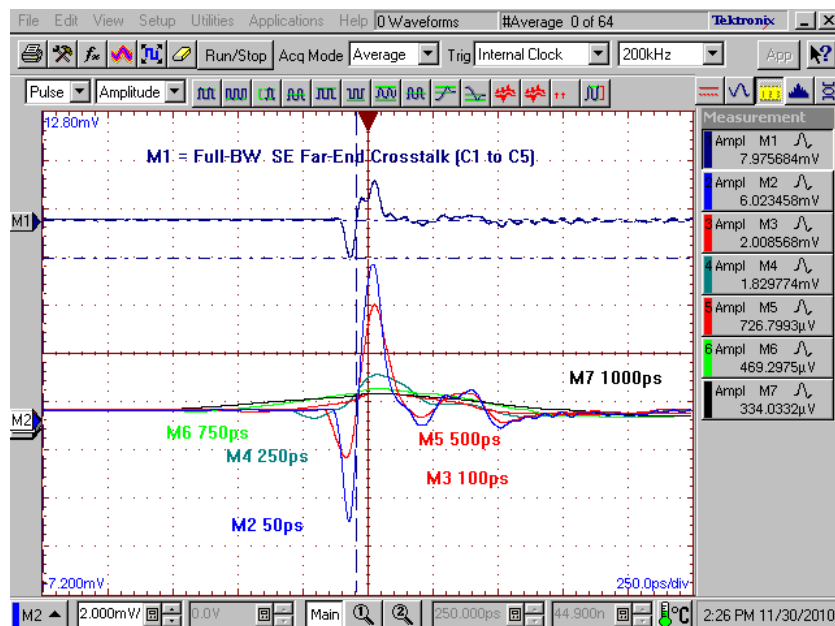

Series: LSHM, High Speed Hermaphroditic Strip, Vertical Surface Mount,
Description: 5.00 mm Stack Height, Two Row, 0.5mm (.0197") Contact Pitch, Board-to-Board

Single-Ended Application – NEXT, Best Case Configuration

LSHM_43 LSHM_39

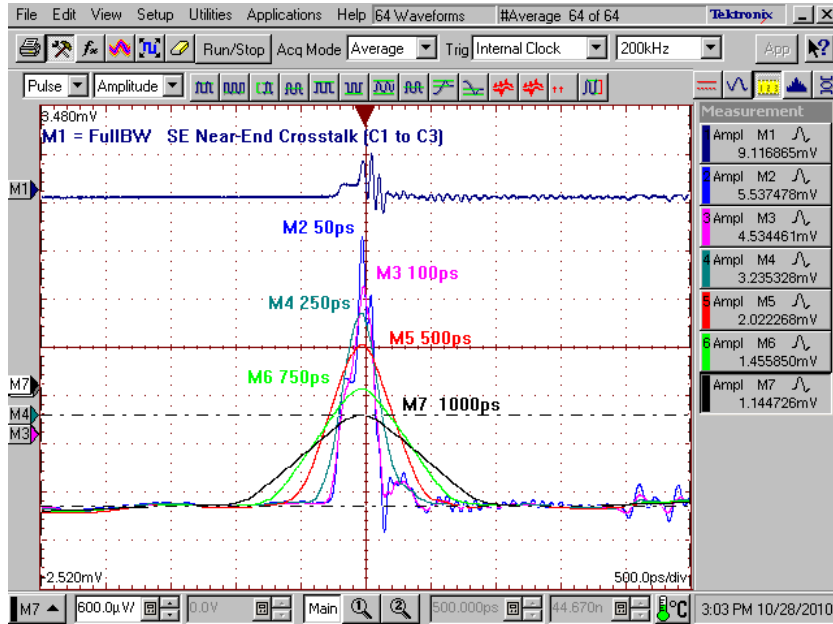

Single-Ended Application – FEXT, Best Case Configuration

LSHM_43 LSHM_40

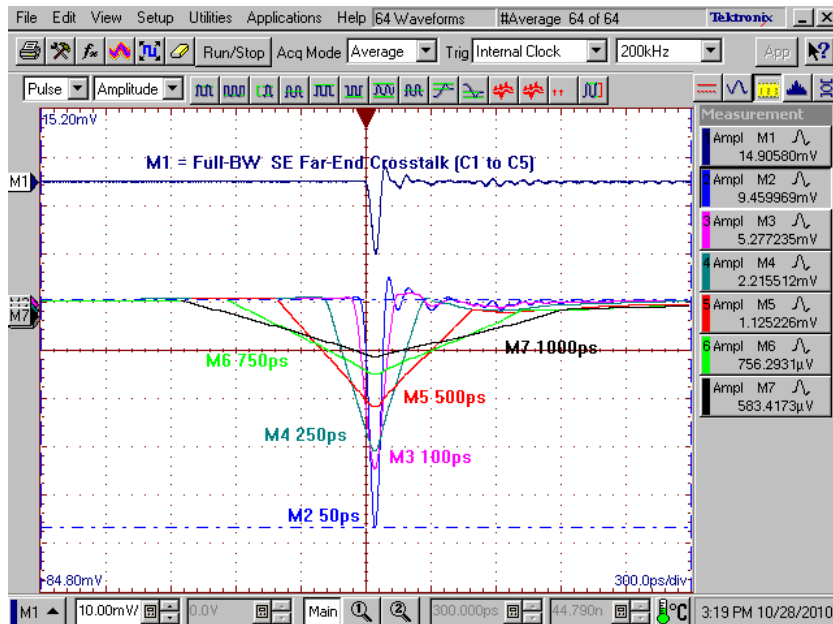

Series: LSHM, High Speed Hermaphroditic Strip, Vertical Surface Mount,
Description: 5.00 mm Stack Height, Two Row, 0.5mm (.0197") Contact Pitch, Board-to-Board

Single-Ended Application – NEXT, Across Row Configuration

LSHM_7 LSHM_8

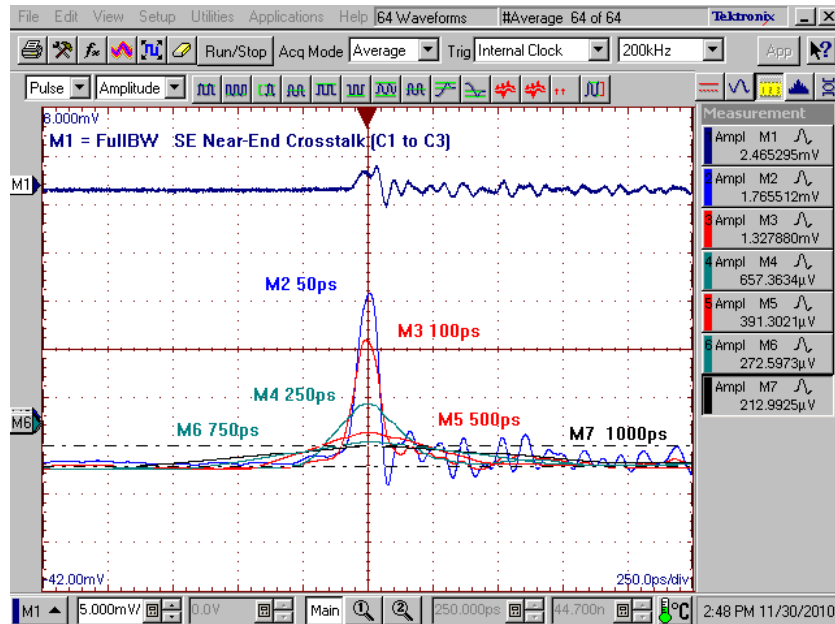

Single-Ended Application – FEXT, Across Row Configuration

LSHM_7 LSHM_7

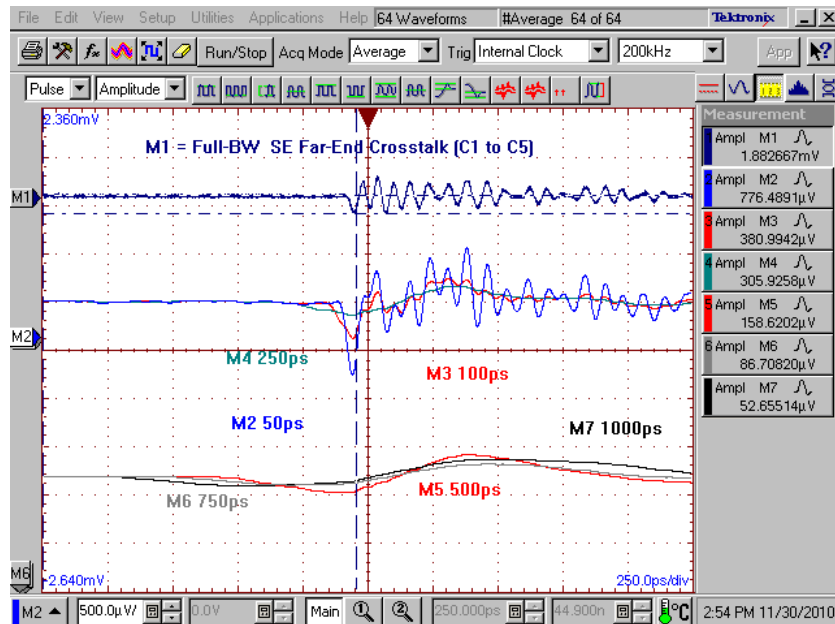

Series: LSHM, High Speed Hermaphroditic Strip, Vertical Surface Mount,
Description: 5.00 mm Stack Height, Two Row, 0.5mm (.0197") Contact Pitch, Board-to-Board

Differential Application – Input Pulse

Port 12= μ probe Tx12 to Port 34= μ probe Rx78

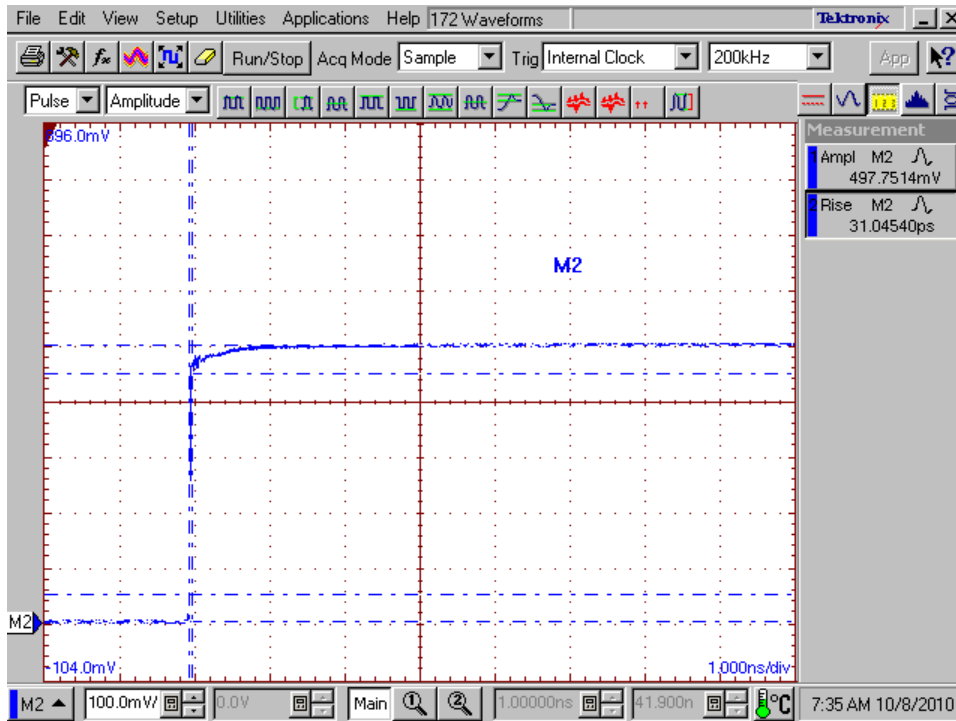

Series: LSHM, High Speed Hermaphroditic Strip, Vertical Surface Mount,
Description: 5.00 mm Stack Height, Two Row, 0.5mm (.0197") Contact Pitch, Board-to-Board

Differential Application – Impedance

Configuration: Tx, port12=LSHM_89-91, Rx, port34=LSHM_90-92

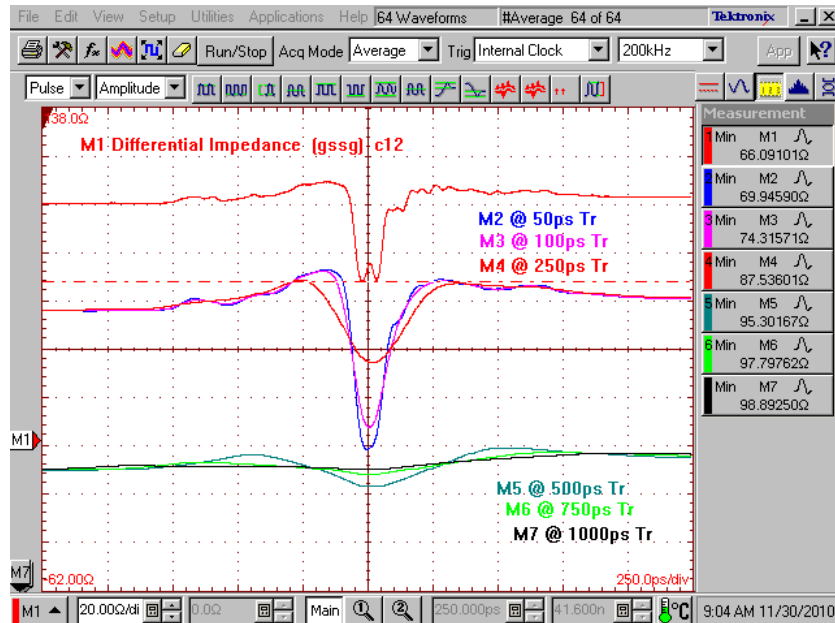

Differential Application – Propagation Delay

Configuration: Tx, port12=LSHM_89-91, Rx, port34=LSHM_90-92

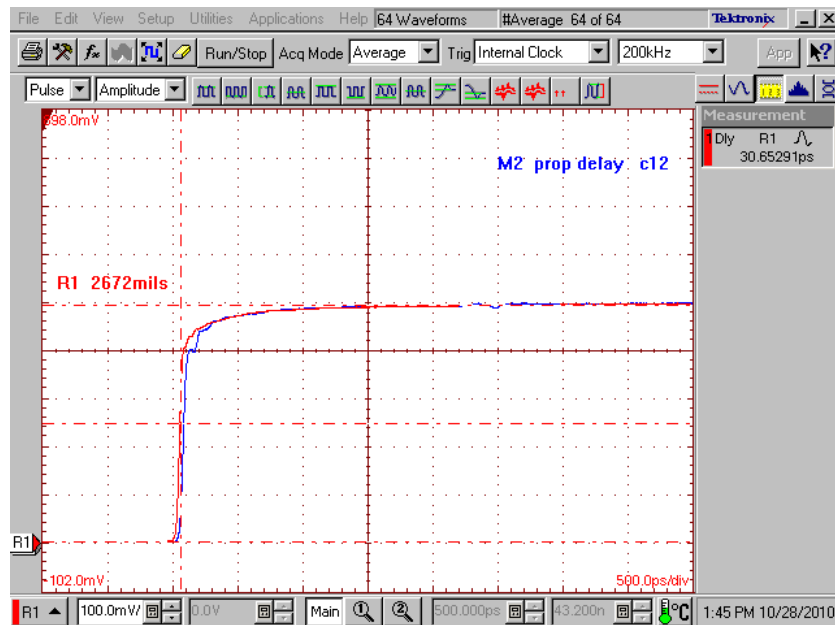

Series: LSHM, High Speed Hermaphroditic Strip, Vertical Surface Mount,
Description: 5.00 mm Stack Height, Two Row, 0.5mm (.0197") Contact Pitch, Board-to-Board

Differential Application – NEXT, Worst Case

LSHM_91-93 LSHM_87-89

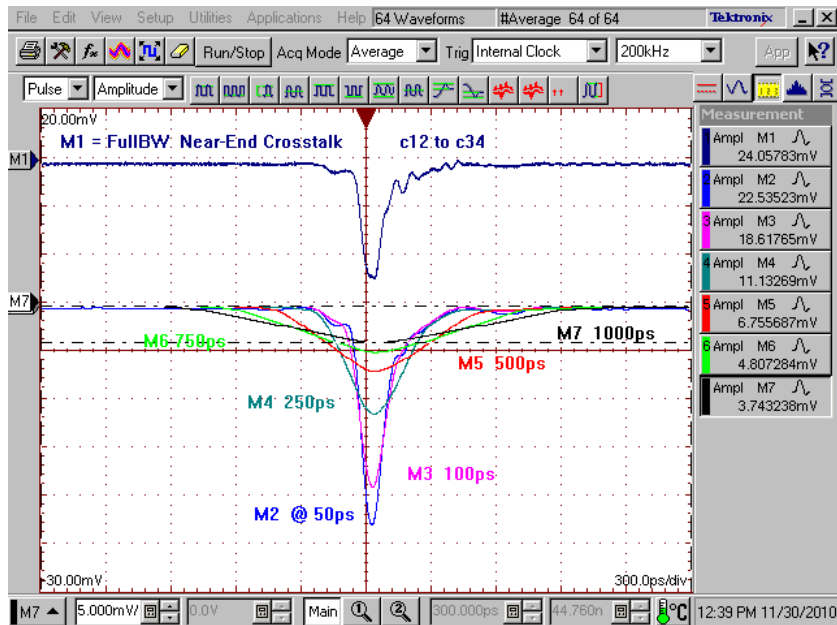

Differential Application – FEXT, Worst Case

LSHM_91-93 LSHM_88-90

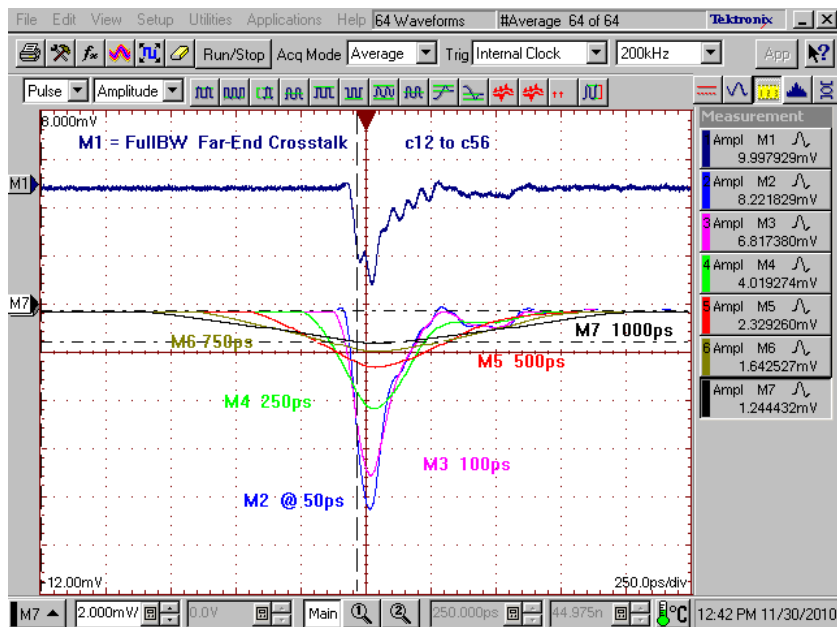

Series: LSHM, High Speed Hermaphroditic Strip, Vertical Surface Mount,
Description: 5.00 mm Stack Height, Two Row, 0.5mm (.0197") Contact Pitch, Board-to-Board

Differential Application – NEXT, Best Case

LSHM_89-91 LSHM_83-85

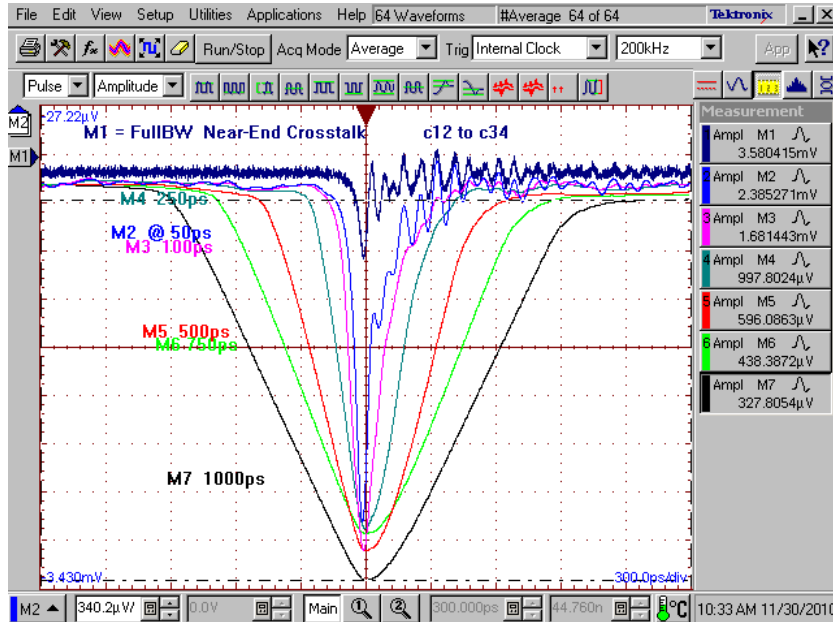

Differential Application – FEXT, Best Case

LSHM_89-91 LSHM_84-86

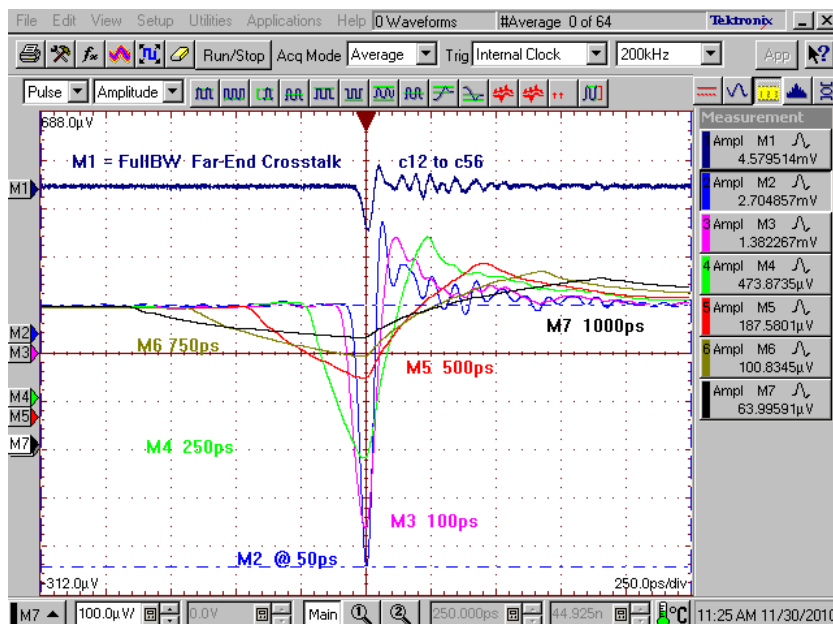

Series: LSHM, High Speed Hermaphroditic Strip, Vertical Surface Mount,
Description: 5.00 mm Stack Height, Two Row, 0.5mm (.0197") Contact Pitch, Board-to-Board

Differential Application – NEXT, Across Row Case

LSHM_3-5 LSHM_4-6

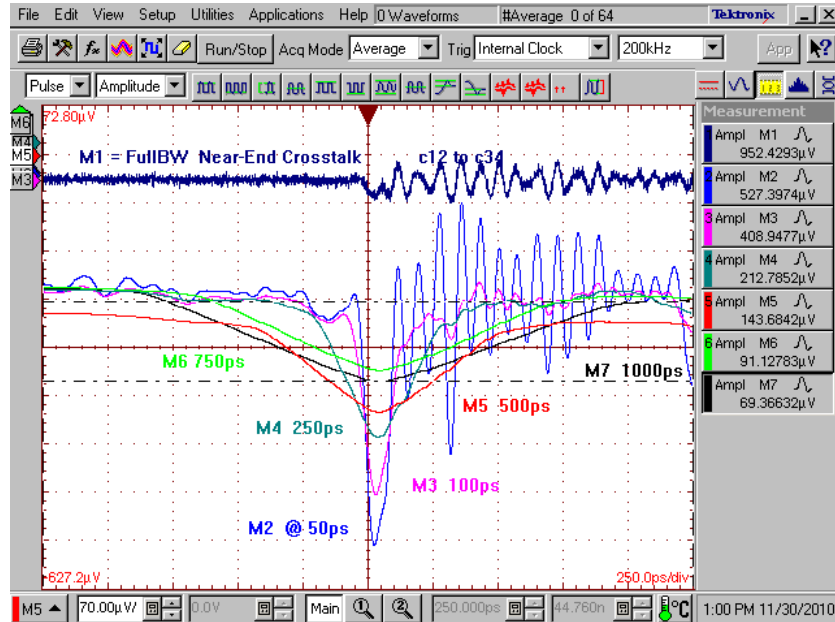

Differential Application – FEXT, Across Row Case

LSHM_3-5 LSHM_3-5

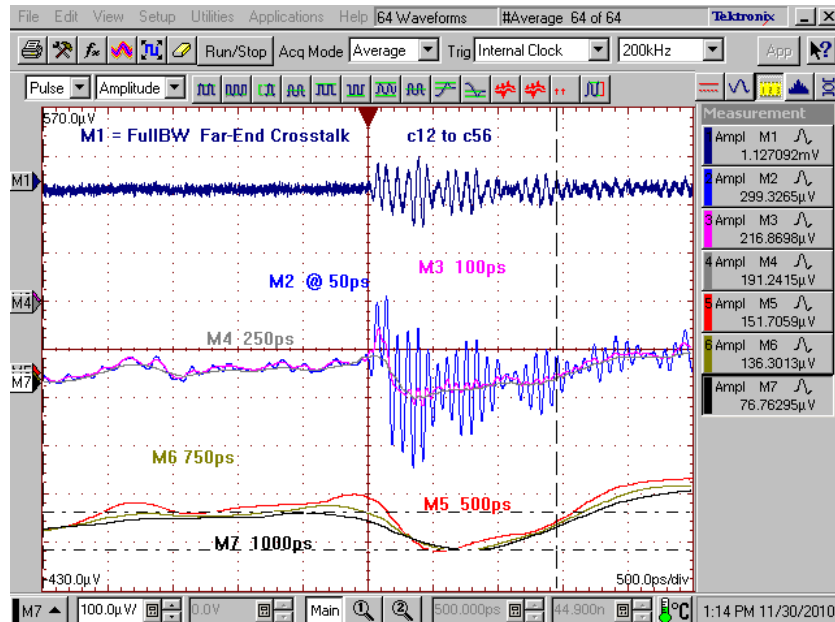

Series: LSHM, High Speed Hermaphroditic Strip, Vertical Surface Mount,

Description: 5.00 mm Stack Height, Two Row, 0.5mm (.0197") Contact Pitch, Board-to-Board

Appendix C – Product and Test System Descriptions

Product Description

Product test samples are the vertical surface mount hermaphroditic part number LSHM-150-06.0-L-DV-A. The LSHM hi-speed characterization reports results on a 2 row, 50 contacts per row, 0.5mm (.0197") contact pitch, 12.0mm stack height board-to-board connector system.

Test System Description

The test fixtures are composed of 4-layer FR-406 material with 50Ω and 100Ω signal trace and pad configurations designed for the electrical characterization of Samtec hi-speed connector products. LSHM 0.5mm series test fixture labels identify PCB-102612-TST-11, PCB-102612-TST-12, PCB-102612-TST-21, and PCB-102612-TST-22. Electrical continuity exists between all the labeled test points where -11 mates to -12, and -21 mates to -22. Calibration standards specific to the LSHM 0.5mm series are located on test board labeled PCB-102612-TST-99 REV, LSHM-DV / LSHM-DV CAL BOARD. All data and waveforms presented are results from the lower level LSHM/LSHM test system. Pictured on page 25 are the mated test samples and a printed circuit board layout panel.

Series: LSHM, High Speed Hermaphroditic Strip, Vertical Surface Mount,
Description: 5.00 mm Stack Height, Two Row, 0.5mm (.0197") Contact Pitch, Board-to-Board

PCB-102612-TST – 5.0mm Stack Height Test Fixtures

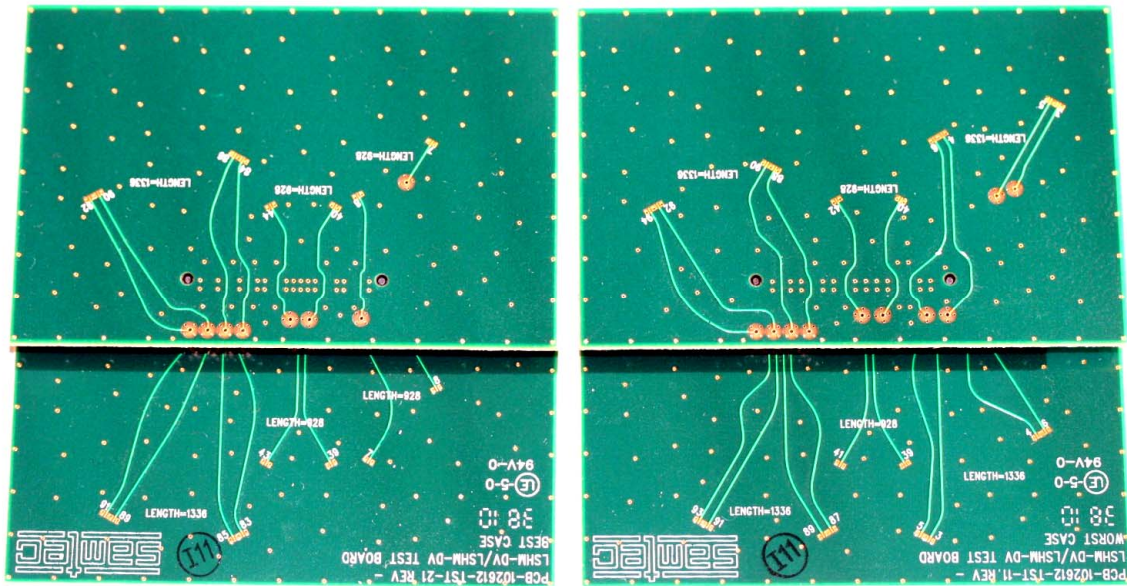

Board -11 mates with Board -12

Board -21 mates with Board -22

PCB-102612-TST PCB Array Panel

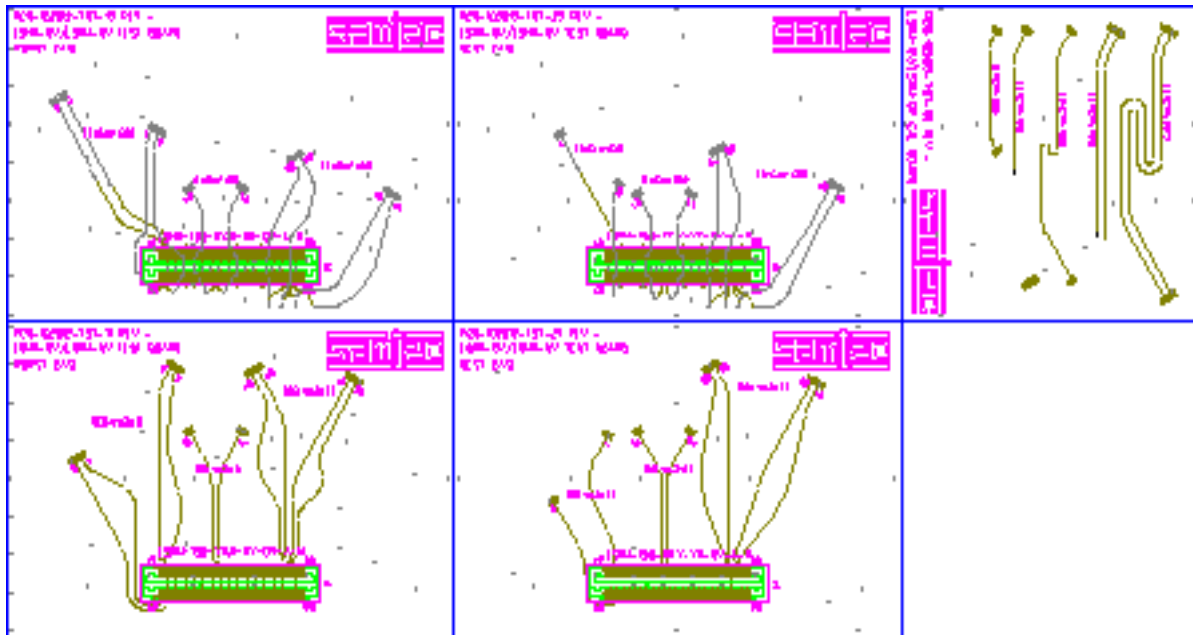

Series: LSHM, High Speed Hermaphroditic Strip, Vertical Surface Mount,
Description: 5.00 mm Stack Height, Two Row, 0.5mm (.0197") Contact Pitch, Board-to-Board

PCB-102612-TST, Set 11 & 12 Mapping

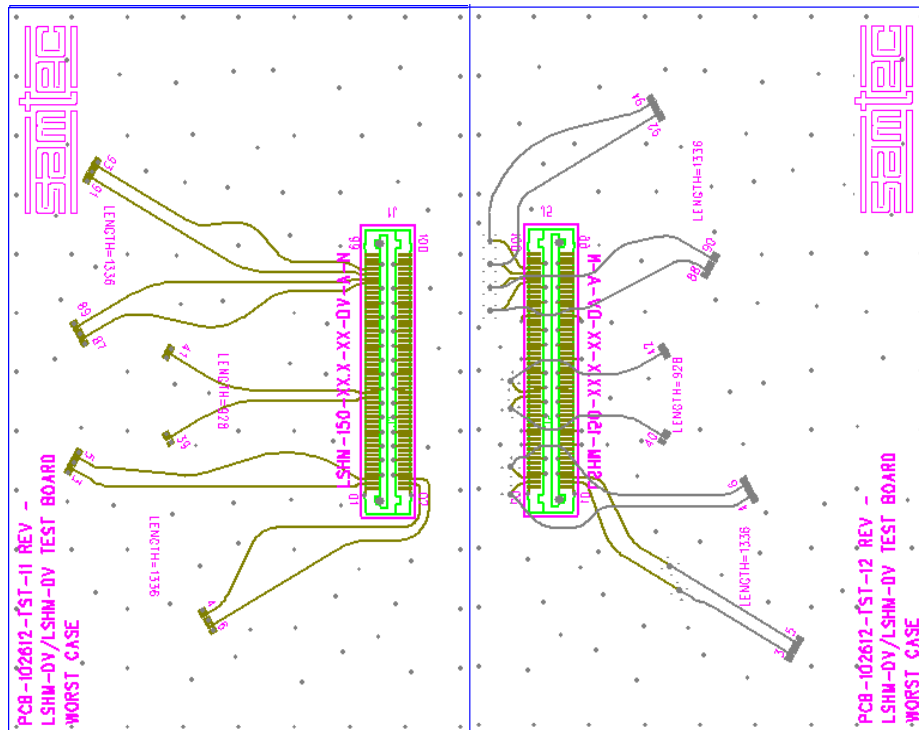

Fixture Test Points – LSHM/LSHM μProbe Test Board, Best Case

| | | | |
|-----------|-------------------|-----------|----------------------|
| Board No. | PCB-102612-TST-11 | Socket: | LSHM-150-02.5-L-DV-A |
| | PCB-102612-TST-12 | Terminal: | LSHM-150-02.5-L-DV-A |

Transmission and Reflection Test Parameters:

Insertion Loss, Return Loss, Impedance, Propagation Delay

Differential:

Single-Ended:

Crosstalk Frequency & Time Domain Response Parameters, NEXT, FEXT

| Signal Type | Sig. to Gnd. Ratio | Near-End Aggressor: | LSHM_91-93 | Victim: | LSHM_87-89 |
|--------------|--------------------|---------------------|------------|---------|------------|
| Differential | Case 1 | Far-End Aggressor: | LSHM_91-93 | Victim: | LSHM_88-90 |
| Single-Ended | Case 2 | Near-End Aggressor: | LSHM_41 | Victim: | LSHM_39 |
| | 2:1, S:G | Far-End Aggressor: | LSHM_41 | Victim: | LSHM_40 |
| Differential | Case 3 | Near-End Aggressor: | LSHM_3-5 | Victim: | LSHM_4-6 |
| | 2:1, S:G | Far-End Aggressor: | LSHM_3-5 | Victim: | LSHM_3-5 |

Series: LSHM, High Speed Hermaphroditic Strip, Vertical Surface Mount,
Description: 5.00 mm Stack Height, Two Row, 0.5mm (.0197") Contact Pitch, Board-to-Board

PCB-102612-TST, Set 21 & 22 Mapping

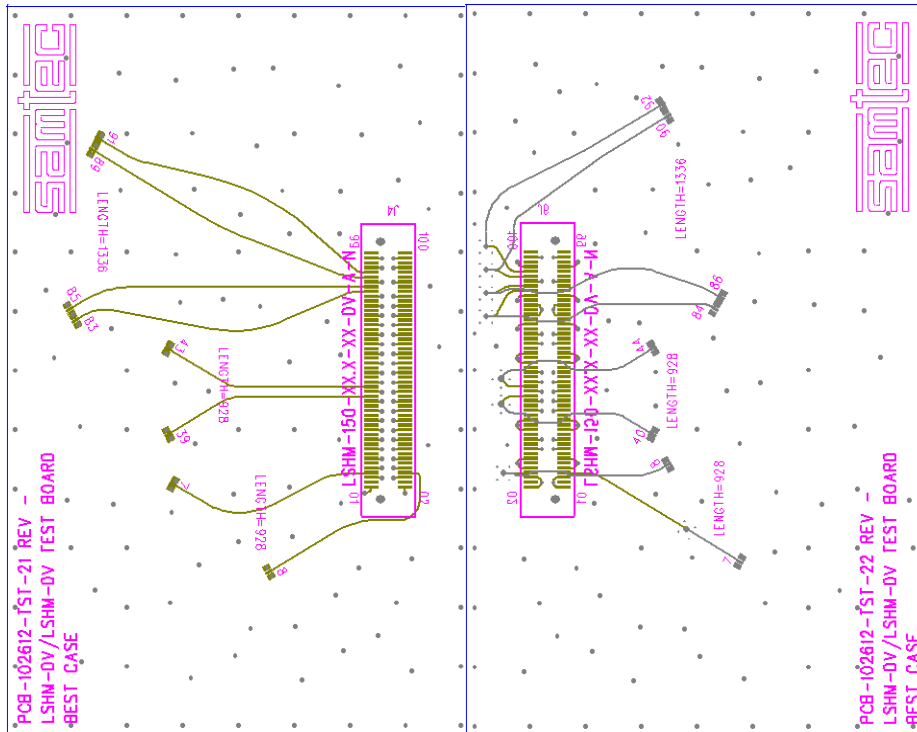

Fixture Test Points – LSHM/LSHM μ Probe Test Board, Best Case

| | | | |
|-----------|-------------------|-----------|----------------------|
| Board No. | PCB-102612-TST-21 | Socket: | LSHM-150-02.5-L-DV-A |
| | PCB-102612-TST-22 | Terminal: | LSHM-150-02.5-L-DV-A |

Transmission and Reflection Test Parameters:

Insertion Loss, Return Loss, Impedance, Propagation Delay

Differential: Tx, port12=LSHM_89-91, Rx, port34=LSHM_90-92

Single-Ended: Tx, port1=LSHM_43, Rx, port3=LSHM_44

Crosstalk Frequency & Time Domain Response Parameters, NEXT, FEXT

| Signal Type | Sig. to Gnd. Ratio | | | | |
|--------------|--------------------|---------------------|------------|---------|------------|
| Differential | Case1 1:1, S:G | Near-End Aggressor: | LSHM_89-91 | Victim: | LSHM_83-85 |
| | | Far-End Aggressor: | LSHM_89-91 | Victim: | LSHM_84-86 |
| Single-Ended | Case 2 1:1, S:G | Near-End Aggressor: | LSHM_43 | Victim: | LSHM_39 |
| | | Far-End Aggressor: | LSHM_43 | Victim: | LSHM_40 |
| Single-Ended | Case 3 1:1, S:G | Near-End Aggressor: | LSHM_7 | Victim: | LSHM_8 |
| | | Far-End Aggressor: | LSHM_7 | Victim: | LSHM_7 |

Series: LSHM, High Speed Hermaphroditic Strip, Vertical Surface Mount,
Description: 5.00 mm Stack Height, Two Row, 0.5mm (.0197") Contact Pitch, Board-to-Board

Micro-Probe TDA Calibration Board

Propagation Delay Thru Length
Differential, 2672mils

Propagation Delay Thru Length
Single-Ended, 1856 mils

TDA Step Waveform
Transmission/Reflection Standard

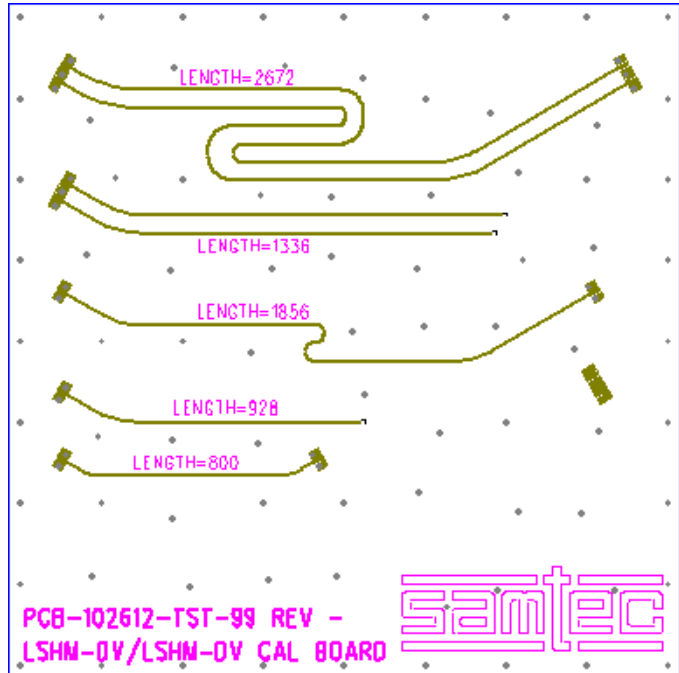
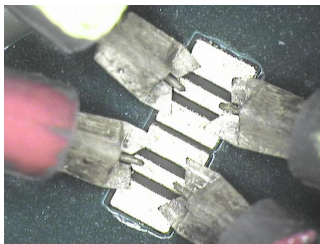

CS-9 Calibration Substrate (SOLT)

OPEN
SHORT
LOAD
THRU

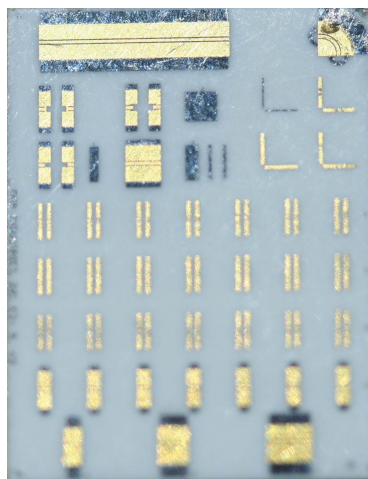

Series: LSHM, High Speed Hermaphroditic Strip, Vertical Surface Mount,
Description: 5.00 mm Stack Height, Two Row, 0.5mm (.0197") Contact Pitch, Board-to-Board

Appendix D – Test and Measurement Setup

Characterization instruments are the Agilent 5230C 4-port PNA analyzer and the Tektronix CSA8000 Communication Signal Analyzer utilizing four Tektronix 80E04 TDR/Sampling Heads. Test sample probing employs a Keyence Video Microscopy system, a Giga Test Labs probing station and Picoprobe 40GHz capable microprobes. Picoprobes' four hundred and fifty micron pitch probes are located to PCB launch points with 25X to 175X magnification and XYZ fine positioning adjustments available on both the probe table and articulating micro-probe positioners. Electrically the microwave probes rate a < 1.0 dB insertion loss, a ≥ 18 dB return loss, and an isolation of 38 dB providing high-bandwidth and low parasitic measurement results. Combined, the above technology provides a stable measurement environment along with the electrical accuracies for obtaining precise calibrations and signal launch capabilities.

Currently the data captured is real time (CSA8000) which is post-processed to s-parameter results employing TDA IConnect modeling software. However, either instrument capabilities allow for automated capturing, post-processing and graphical waveform representation in both domains. In a move towards full s-parameter reporting, future SI characterization reports will include PNA generated s-parameters utilizing the advantage of SOLT or TRL calibration accuracy. The end game for full s-parameter reporting will be PNA based with TRL calibration and de-embedding accuracy. All s-parameter and timing based measurements will be generated utilizing Advanced Systems Design simulation software. Appendix E will retain procedures for TDA IConnect. Procedures added to Appendix E include PNA s-parameter methods and SOLT calibration. Until full implementation of the s-parameter ADS process, impedance, propagation delay and digital crosstalk will continue to be generated by the CSA8000. Frequency based PNA s-parameter measurements will replace the IConnect processed s-parameter data. Those PNA s-parameter formats include insertion loss, return loss and RF crosstalk.

CSA8000 Time Domain Test Setup

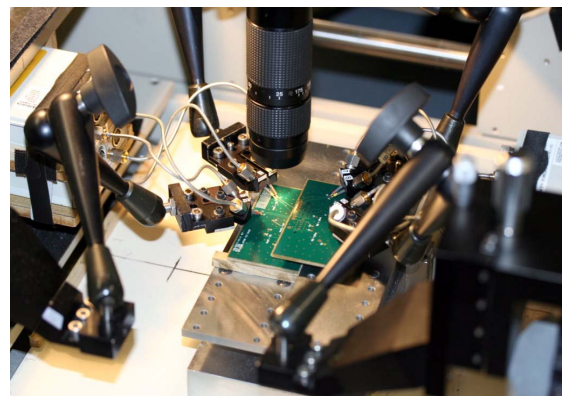
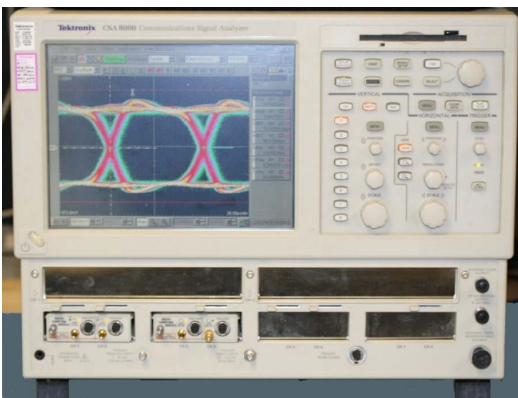

Series: LSHM, High Speed Hermaphroditic Strip, Vertical Surface Mount,
Description: 5.00 mm Stack Height, Two Row, 0.5mm (.0197") Contact Pitch, Board-to-Board

N5230C Frequency Domain (S-Parameter) Test Setup

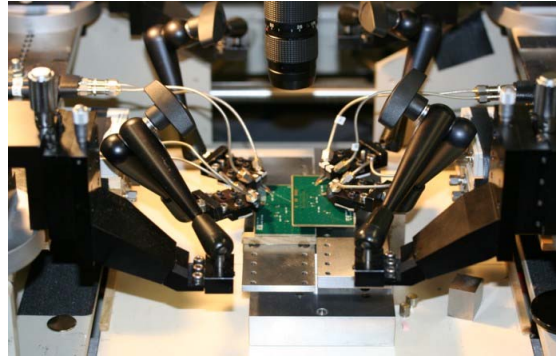
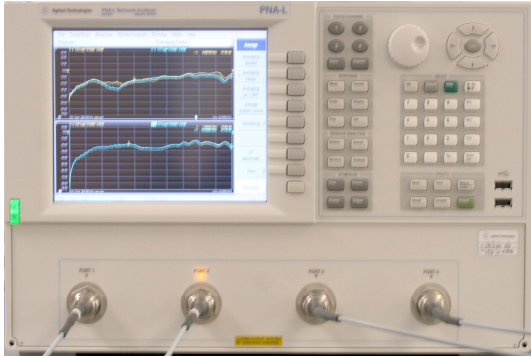

Test Instruments

| <u>QTY</u> | <u>Description</u> |
|------------|---|
| 1 | Agilent N5230C PNA 300KHz to 20 GHz |
| 1 | Tektronix CSA8000 Communication Signal Analyzer |
| 4 | Tektronix 80E04 Dual Channel 20 GHz TDR Sampling Module |

Probe Station Accessories

| <u>QTY</u> | <u>Description</u> |
|------------|--|
| 1 | GigaTest Labs Model (GTL3030) Probe Station |
| 4 | GTL Micro-Probe Positioners |
| 4 | Picoprobe by GGB Ind. Dual Model 40A GSG-GSG |
| 1 | GGB Industries CS-9 Calibration Substrate (SOLT standards) |
| 1 | Keyence VH-5910 High Resolution Video Microscope |
| 1 | Keyence VH-W100 Fixed Magnification Lens 100 X |
| 1 | Keyence VH-Z25 Standard Zoom Lens 25X-175X |

Test Cables & Adapters

| <u>QTY</u> | <u>Description</u> |
|------------|--|
| 8 | Pasternack Enterprises 2.9mm Semi-Rigid (.086) 6" Cable Assemblies (4) |
| 4 | MegaPhase CM40-K1K2-48 Chip Set Cables (40GHz) |
| 4 | Tektronix 1 Meter Module Extenders |

Calibration Kits

| <u>QTY</u> | <u>Description</u> |
|------------|--|
| 1 | GGB Industries, Picoprobe CS – 9 Calibration Substrate |

Series: LSHM, High Speed Hermaphroditic Strip, Vertical Surface Mount,

Description: 5.00 mm Stack Height, Two Row, 0.5mm (.0197") Contact Pitch, Board-to-Board

Appendix E - Frequency and Time Domain Measurements

It is important to note before gathering measurement data that TDA Systems IConnect measurements and CSA8000 measurements are virtually the same measurements with diverse formats. This means that the operator, being extremely aware, can obtain SI time and frequency characteristics in an almost simultaneous fashion.

Since IConnect setup procedures are specific to the frequency information sought, it is mandatory that the sample preparation and CSA8000 functional setups be consistent throughout the waveform gathering process. If the operators test equipment permits recall sequencing between the various test parameter setups, it insures IConnect functional setups remain consistent with the TDR/TDT waveforms previously recorded.

Sample Preparation

Determine signal launch and monitoring test points by referencing the detailed pin-out maps provided in Appendix E. Pinout maps names are;

Microprobe Calibration Board, [TDA](#)

PCB Fixture Set [I](#)

PCB Fixture Set [II](#)

It is good practice to terminate all non-active signal lines immediately adjacent to the designated active or quiet signal lines under test.

Frequency Domain Procedures

TDA IConnect S-Parameter Extraction & Processing

Frequency data extraction involves a two-step process. The first step creates the TDR based waveform relationships utilizing a Tektronix CSA8000 time based instrument. The second step involves the conversion of these time-based waveforms into s-parameter format using the TDA Systems IConnect software tool. TDA Systems labels time related conversion waveforms as the *Step* and *DUT* waveform references. This section establishes the setup procedures for defining the *Step* and *DUT* reference for conversion to frequency s-parameters presented in this report.

CSA8000 Setup

Listed below is the CSA 8000 functional menu setups used for single-ended and differential frequency response extractions. Both signal types utilize I-Connect software tools to generate S-parameter upper and lower frequency boundaries along with the step frequency. Functional settings such as window length, number of points and averaging

Series: LSHM, High Speed Hermaphroditic Strip, Vertical Surface Mount,
Description: 5.00 mm Stack Height, Two Row, 0.5mm (.0197") Contact Pitch, Board-to-Board

capability determines the instruments frequency boundaries. Once window length, number of points and averaging functions are set, maintain the same instrument settings throughout the extraction process. The single channel pulsed source processes s-parameters in single-ended format. A dual channel differential pulsed source processes s-parameters in differential format.

| | <u>Single-Ended Signal</u> | <u>Differential Signal</u> |
|---------------------|---------------------------------------|---------------------------------------|
| Vertical Scale: | 100 mV/ Div: | 100 mV/ Div: |
| Offset: | Default / Scroll | Default / Scroll |
| Horizontal Scale: | 1nSec/ Div = 20 MHz step frequency | 1nSec/ Div = 20 MHz step frequency |
| Max. Record Length: | 4000 = Min. Resolution | 4000 = Min. Resolution |
| Averages: | ≥ 128 | ≥ 128 |

Insertion Loss (TDA conversion)

STEP Waveform - determine TD waveform by making a TDT transmission measurement that includes all cables, adapters, and probes connected in the test systems transmission path. Complete the transmission path by inserting a negligible length of transmission standard between the system test probes. Calibration or waveform referencing utilizes a six pad cal structure for each of the probe touchdowns (ie; se thru = 3 pads or diff thru = 6 pads). Reference the [TDA](#) calibration board, and use the 1mm (0.390") length calibration reflect/transmission structure for TDA step waveform characterization.

DUT Waveform - determine TD waveform by making an active TDT transmission measurement that includes all cables, adapters, and probes connected in the test systems transmission path. Insert the SUT between the probes in place of the TDA reflection/transmission standard and record the measurement. Reference PCB fixture set [II](#) for Insertion Loss configurations.

Return Loss (TDA conversion)

STEP Waveform – determine TD waveform by making an active TDR reflection measurement that includes all cables, adapters, and probes connected in the test systems electrical path up to and including an open standard. Calibration or waveform referencing utilizes three pads for each probe touchdown (ie; se reflect = 3 pads or diff reflect = 6 pads). Reference the [TDA](#) calibration board and use the 1mm (0.390") length calibration reflect/transmission standard for TDA step waveform characterization.

DUT Waveform – determine waveform by making an active TDR reflection measurement that includes all cables, adapters, and probes connected in the test systems transmission path. Insert the SUT between the probes in place of the reflection standard. In this condition cables and adapters located at the far-end of the inserted SUT function as the systems 50Ω single-ended and/or 100Ω differential matching impedance. Reference PCB fixture set [II](#) for Return Loss configurations.

Series: LSHM, High Speed Hermaphroditic Strip, Vertical Surface Mount,

Description: 5.00 mm Stack Height, Two Row, 0.5mm (.0197") Contact Pitch, Board-to-Board

Near-End Crosstalk (TDA conversion)

STEP Waveform – Use Return Loss (RL) step waveform.

DUT Waveform - determine waveform by driving specified signal type and monitoring coupled energy levels at the configurations adjacent near-end signal line. Reference PCB fixture sets [I](#) and [II](#) for NEXT configurations.

Far-End Crosstalk (TDA conversion)

STEP Waveform - Use Insertion Loss (IL) step waveform.

DUT Waveform - determine waveform by driving specified signal type and monitoring coupled energy levels at the configurations adjacent far-end signal line. Reference PCB fixture sets [I](#) and [II](#) for FEXT configurations.

PNA Calibration & S-Parameter Measurements

Valid S-Parameter measurements require a frequency driven instrument with IO capabilities compatible with the many different mating interfaces of a precision type calibration kit. Requirements meet in this test with the N5230C PNA as the source instrument and the Picoprobe CS-9 substrate serving as the precision SOLT type calibration kit.

N5230C PNA Setup

Frequency Sweep: Linear, 300 KHz to 20 GHz, Data Points: 6401, RBW: 1KHz, Cal Type: (3*) Full 4-port: Defined Calibration Kit ID: 40 – Dual Microprobe, Location: Calibration/Advanced Modify Cal Kit/ ID: 40, Calibration Substrate: [CS-9](#),

Calibration Filename: * **4P_p12-to-p78_μprobe**

Calibrated reflective reference exists at microprobe GSG tip #'s 1, 2, 7 & 8

Calibrated Thru references exist at 1-2 to 8-7 & 1 to 8 or 2-7

Provides s-parameter information for Insertion Loss, Return Loss

Calibration Filename: * **4P_p12-to-p34_μprobe**

Calibrated reflective reference exists at microprobe GSG tip #'s 1, 2, 3 & 4

Calibrated Thru references exist at 1-2 to 3-4 & 1 to 3 or 2-4

Provides s-parameter information for RF Near-End Crosstalk

Calibration Filename: * **4P_p12-to-p56_μprobe**

Calibrated reflection reference plane are at microprobe GSG tip #'s 1, 2, 5 & 6

Calibrated Through reference planes are 1-2 to 5-6 & 1 to 5 or 2-6

Provides s-parameter information for RF Far-End Crosstalk

Series: LSHM, High Speed Hermaphroditic Strip, Vertical Surface Mount,

Description: 5.00 mm Stack Height, Two Row, 0.5mm (.0197") Contact Pitch, Board-to-Board

Time Domain Procedures

Utilize the Time Domain Reflectometer (TDR) or Time Domain Transmission (TDT) method for digital type pulse measurements. Impedance and propagation delay characterization utilize TDR measurement methods. Crosstalk measurements utilize TDT methods. The Tektronix 80E04 TDR/ Sampling Head provide both the signaling type and sampling capability necessary to characterize the SUT.

Impedance(TDR)

Energize the SUT's signal line(s) with a TDR pulse. The far-end of the energized signal lines are terminated in the test systems characteristic impedance (e.g.; 50Ω or 100Ω termination) or use quality cables and adapters located at the far-end of the inserted SUT function as the systems 50Ω single-ended and/or 100Ω differential matching impedance. Reference PCB fixture set [II](#) for Impedance configurations.

Propagation Delay (TDT)

This test reports differential or single ended signal delay as the measured difference of propagation between a combined electrical length of the input/output signal pads and traces (35 ± 5 ps edge rate) and the device under test (DUT) plus a referenced electrical length of the signal pads and signal traces ($PD^{\text{pads/traces}} - PD^{\text{DUT}} + PD^{\text{pads/traces}}$). The recorded delay is the signal delay of the connector only. $PD^{\text{pads/traces}}$ is the nomenclature representing the electrical length of PCB signal pads & traces equal to physical lengths of PCB pads & traces entering and leaving the device under test (DUT). The $PD^{\text{DUT}} + PD^{\text{pads/traces}}$ variable is the mated DUT fixture. Measure the risetime of $PD^{\text{pads/traces}}$ waveform & $PD^{\text{DUT}} + PD^{\text{pads/traces}}$ waveforms. Record the 50% amplitude of each rising edge. The distance in time between the rising edges is the propagation delay of the device under test (DUT). Reference the [TDA](#) calibration board for trace lengths. Reference PCB fixture set [II](#) for Propagation Delay configurations.

Near-End Crosstalk (TDT)

Energize the pre-determined signal line(s) with the appropriate signal type. Monitor the configurations adjacent quiet signal line at the near-end for magnitudes of coupled energy. Terminate adjacent signal lines not under test in the test systems characteristic impedance. Reference both PCB fixture set [I](#) and fixture set [II](#) for crosstalk configurations.

Far-End Crosstalk (TDT)

Energize the pre-determined signal line(s) with the appropriate signal type. Monitor the configurations adjacent quiet signal line at the far-end for magnitudes of coupled energy. Terminate adjacent signal lines not under test into the test systems characteristic impedance. Reference both PCB fixture set [I](#) and fixture set [II](#) for crosstalk configurations.

Series: LSHM, High Speed Hermaphroditic Strip, Vertical Surface Mount,

Description: 5.00 mm Stack Height, Two Row, 0.5mm (.0197") Contact Pitch, Board-to-Board

Appendix F – Glossary of Terms

ADS – Advanced Design Systems

BC – Best Case crosstalk configuration

DUT – Device under test, term used for TDA IConnect & Propagation Delay waveforms

EC6 – Edge Card with a .635mm signal pad pitch

FD – Frequency domain

FEXT – Far-End Crosstalk

GSG – Ground–Signal–Ground; geometric configuration

GSSG - Ground–Signal–Signal–Ground; geometric configuration

HDV – High Density Vertical

LEC6 – Signal Launch Edge Card with a .635 mm signal pad pitch

NEXT – Near-End Crosstalk

OV – Optimal Vertical

OH – Optimal Horizontal

PCB – Printed Circuit Board

PPO – Pin Population Option

SE – Single-Ended

SI – Signal Integrity

SUT – System Under Test

S – Static (independent of PCB ground)

SOLT – acronym used to define Short, Open, Load & Thru Calibration Standards

TD – Time Domain

TDA – Time Domain Analysis

TDR – Time Domain Reflectometry

TDT – Time Domain Transmission

WC – Worst Case crosstalk configuration

Z – Impedance (expressed in ohms)